

T802

IN-LINE SLIDING DOOR SYSTEM

小平趟

专利产品;

柜门关闭后在同一平面,整体美观、大气;

大量采用高强度轴承,单门承重20kg;

柜门关闭时采用阻尼系统;

适用于门厚度为15-22mm的木门、框门、铝框门;

滑轮组件采用新颖结构,使轨道能在1150-1750mm,1750-2350mm之间任意裁切。

Patented product;

Two doors close in one piece, neat looking;

Brush on runners, smooth and silent;

Single door loading capacity: 20kg;

Apply to length of rail: 1150-1750mm, 1750-2350mm;

Apply to thickness of door: 15-22mm wooden door, frame door;

Aluminum frame door.



配件名称 Accessories	数量 Qty	配件图 Drawing
上轨道组件 Upper Rail	1	
802A连杆组件 Connecting rod component	2	
门板侧导向轨 Door panel side direction rail	4	
右门中间调节器 Right door middle regulator	1	
右门侧边调节器 Right door side regulator	1	
左门中间调节器 Left door middle regulator	1	
左门侧边调节器 Left door side regulator	1	

产品型号及规格 Product specification

产品型号 Item code	适用柜体内宽 Cabinet inner width	轨道可裁切范围 Cutttable rail range	门宽范围 (门板盖侧板25mm) Door width (door panel cover side panel 25mm)	门高范围 Door height
T802A-1750	1750mm	1150mm--1750mm	600mm--900mm	≤1000mm
T802A-2350	2350mm	1750mm--2350mm	900mm--1200mm	≤1500mm

吊柜安装 Hanging cabinet installation

X=顶板厚度
E=门板盖底板厚度
X=Top panel thickness
E=Thickness of door panel cover bottom panel

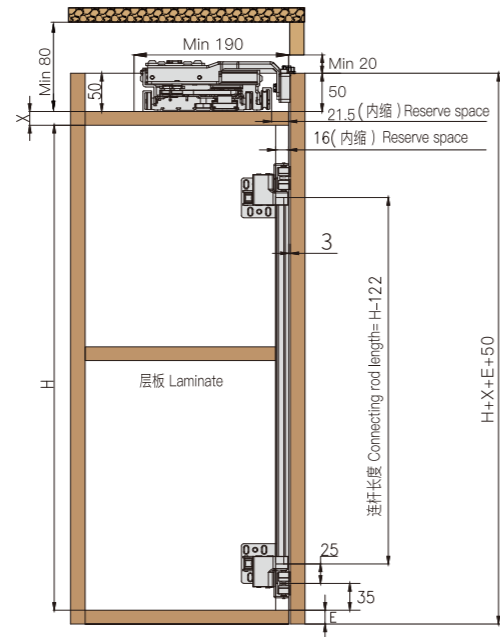

柜体要求 Cabinet requirements

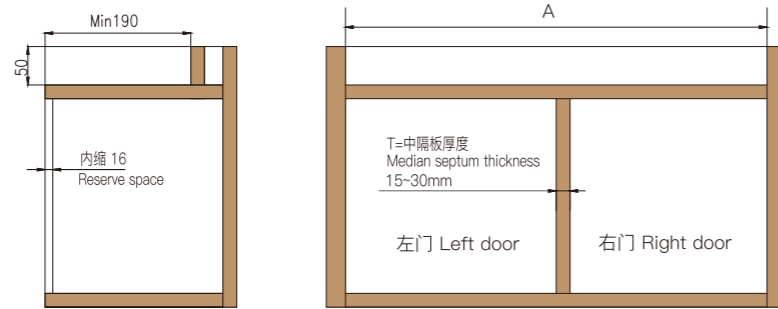

门板尺寸参考 Door size

A=柜体内宽
D=门缝(3-5mm)
B=门板盖侧板宽度(-3-25mm)
C=门板宽度=(A+2B-D)/2
A=Cabinet inner width
D=Door gap(3-5mm)
B=Width of door panel cover side panel(-3-25mm)
C=Door width=(A+2B-D)/2

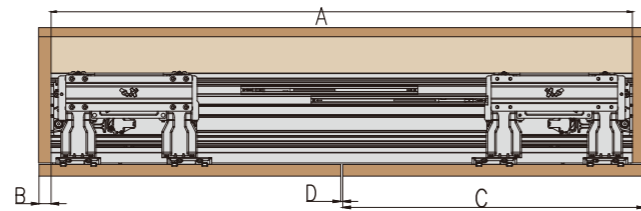

门板配件安装 Door accessories inatallation

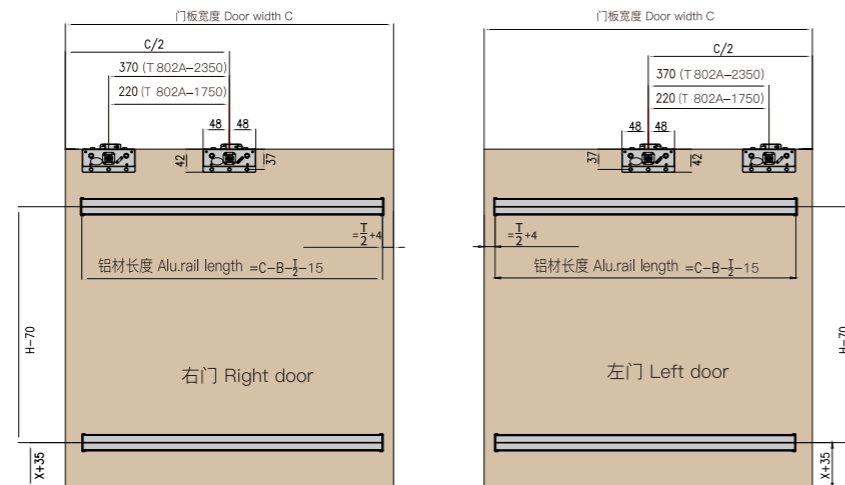

地柜安装 Floor cabinet installation

X=门板盖顶板厚度
E=底板厚度
X=Thickness of door panel cover top panel
E=Bottom panel thickness

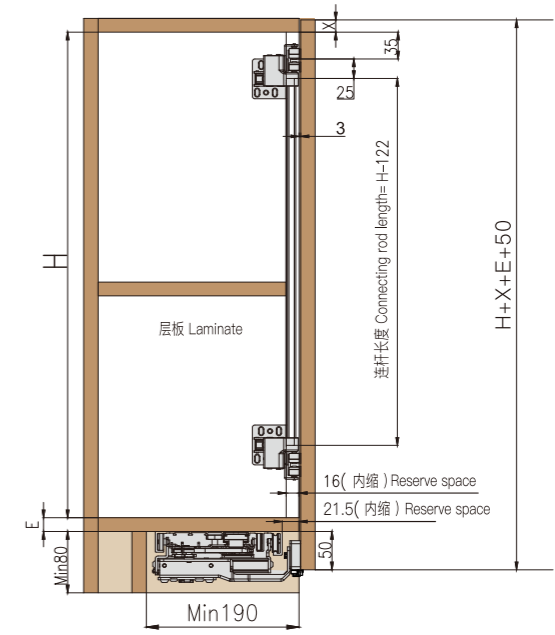

柜体要求 Cabinet requirements

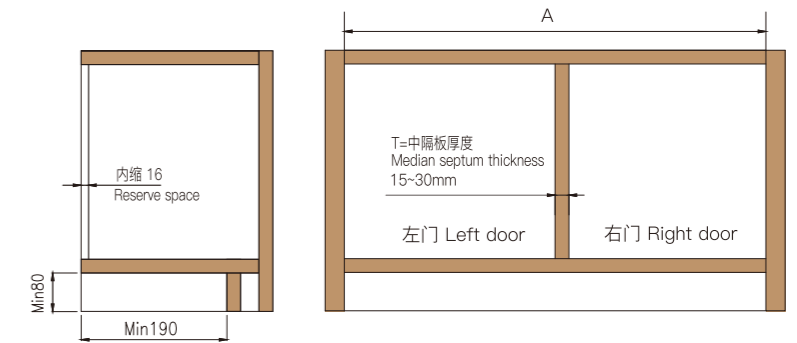

门板尺寸参考 Door size

A=柜体内宽
D=门缝(3-5mm)
B=门板盖侧板宽度(-3-25mm)
C=门板宽度=(A+2B-D)/2
A=Cabinet inner width
D=Door gap(3-5mm)
B=Width of door panel cover side panel(-3-25mm)
C=Door width=(A+2B-D)/2

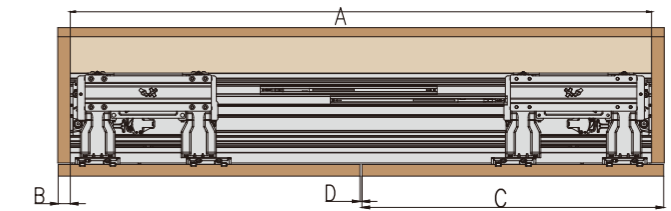

门板配件安装 Door accessories inatallation

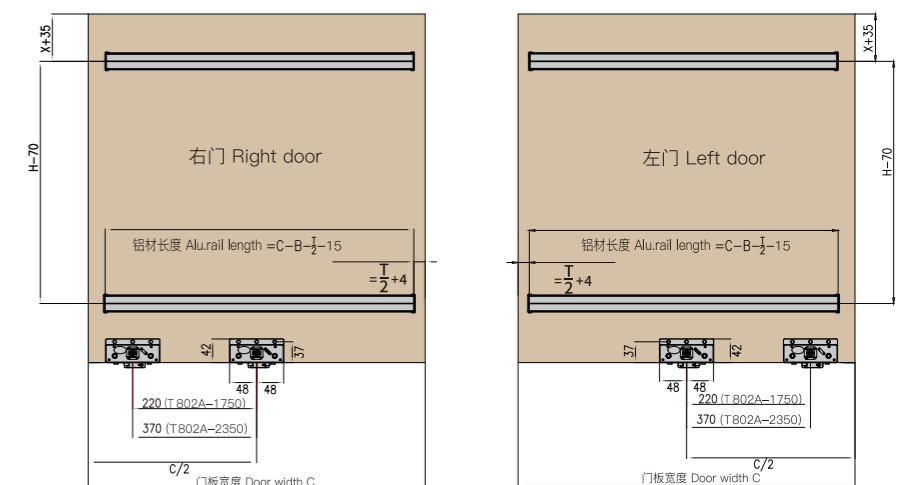

T803



CUTTABLE IN-LINE SLIDING DOOR SYSTEM

可裁切平趟门

专利产品；
可裁切轨道；
新颖弯轨及滑轮结构，柜门关闭时在同一平面，整体美观、大气；
双向阻尼缓冲，轻柔闭合，延长家具寿命；
自动清洁毛刷结构，运行顺畅静音；
采用高强度轴承，单门承重80Kg；
适用门厚18-45mm的木门、框门、铝框门；
轨道在1350-1650mm，1650-2050mm，
2050-2450mm，2450-2850mm内随意裁切。

Patented product;
Cut freely within the range of 1500-3000mm;
Two doors close in one piece, neat looking;
Double soft closing function to achieve long lifespan;
Automatic cleaning brush structure, smooth and silent operation;
Single door loading capacity 80Kg;
Suitable for wooden doors, frame doors and
aluminum frame doors with thickness of 18-45mm
Cut within 1350-1650 mm, 1650-2050 mm,
2050-2450 mm, 2450-2850 mm.

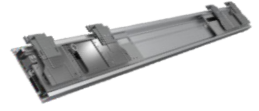

配件名称 Accessories	数量 Qty	配件图 Drawing
T803上轨组件 T803 Upper rail	1	
T803下轨组件 T803 Down rail	1	
T803上轮中间调节器 T803 Upper runner middle regulator	2	
T803上轮侧边调节器 T803 Upper runner side regulator	2	
T803下轮中间调节器 T803 Down runner middle regulator	2	
T803下轮侧边调节器 T803 Down runner side regulator	2	
15-8调节扳手 15-8 Spanner	1	
T803侧边加强拉簧 T803 Side Spring	2	
TH00020橡胶垫 (φ20*2) Th00020 Spacer (φ20*2)	4	

产品型号及规格 Product specification

产品型号 Item code	适配标准柜体内宽 Cabinet standard inner width	轨道可裁切范围 Cutttable rail range	备注 Remark
T803-2050	2050mm	1650mm--2050mm	长度范围内客户可任意裁切或按客户长度定制 Cut freely within the range
T803-2450	2450mm	2050mm--2450mm	长度范围内客户可任意裁切或按客户长度定制 Cut freely within the range
T803-2850	2850mm	2450mm--2850mm	长度范围内客户可任意裁切或按客户长度定制 Cut freely within the range
T803-1650	1650mm	1350mm--1650mm	长度范围内客户可任意裁切或按客户长度定制 Cut freely within the range

安装参数详解 Specification

门板厚度含拉手≤45mm
Door Thickness ≤45mm (Handle included)

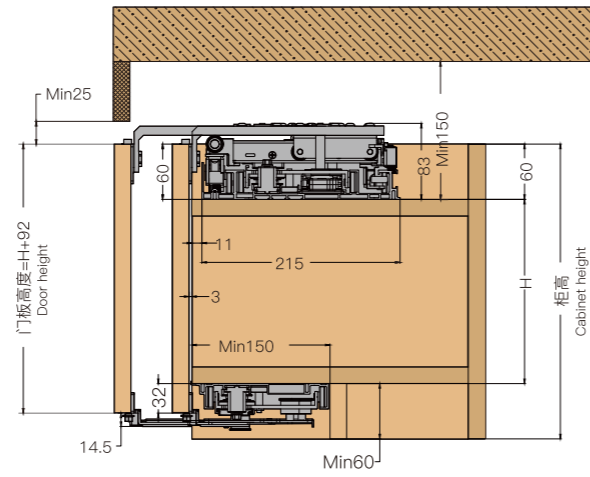

柜体要求 Cabinet requirements

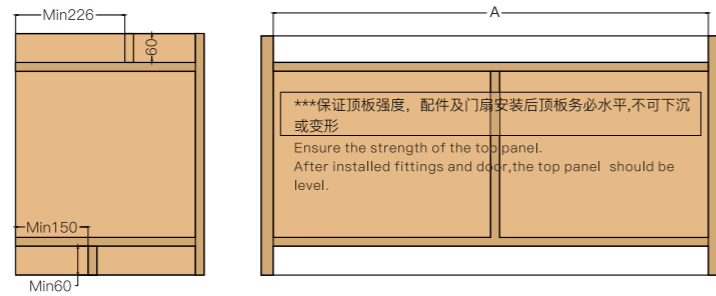

门板不盖侧板
Door panel not cover side panel

A=柜体内宽
B=门缝 (≥4mm)
C=门板盖侧边宽度(≤25mm)
D=门板宽度= (A-2C-B) / 2

A=Inner width of cabinet
B=Gap between two doors(≥4mm)
C=Side panel width(≤25mm)
D=Door width=(A-2C-B)/2

A=标准产品长度
D=门板宽度= (K-2C-2B-E) / 4
E=中间两门门缝
(两门不同时打开E≥3mm;两门同时打开E≥6mm)
K=四门柜体总内宽

***下单根据A值选择T803中一款, 备注单套轨道长度K/2数值即可

A=Single product standard length
D=Door width=(K-2C-2B-E)/4
E=Gap between middle two doors
(two doors not open at same time,E≥3mm, two doors open at same time,E≥6mm)
K=Four door Inner width of cabinet

According to A value to choose the product length, remark Single rail lengths K/2

两门柜体参数图 Two doors cabinet parameters

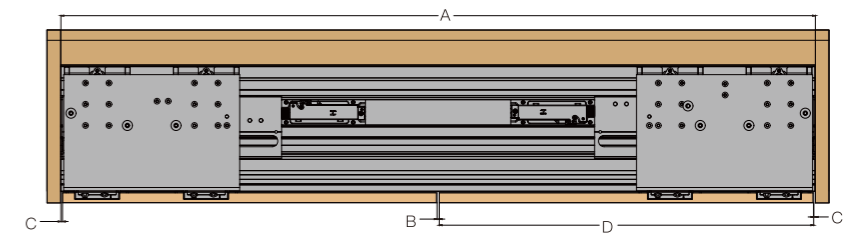

四门柜体参数图 Four doors cabinet parameters

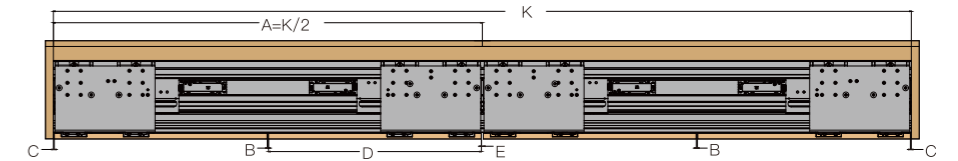

门板盖侧板
Door panel cover side panel

A=柜体内宽
B=门缝 (≥4mm)
C=门板盖侧边宽度(≤25mm)
D=门板宽度= (A+2C-B) / 2

A=Inner width of cabinet
B=Gap between two doors(≥4mm)
C=Side panel width(≤25mm)
D=Door width=(A+2C-B)/2

A=单套产品长度
D=门板宽度= (K+2C-2B-E) / 4
E=中间两门门缝
(两门不同时打开E≥3mm;两门同时打开E≥6mm)
K=四门柜体总内宽

***下单根据A值选择T803中一款, 备注单套轨道长度K/2数值即可

A=Single product standard length
D=Door width=(K+2C-2B-E)/4
E=Gap between middle two doors
(two doors not open at same time,E≥3mm, two doors open at same time,E≥6mm)
K=Four door Inner width of cabinet

According to A value to choose the product length, remark Single rail lengths K/2

两门柜体参数图 Two doors cabinet parameters

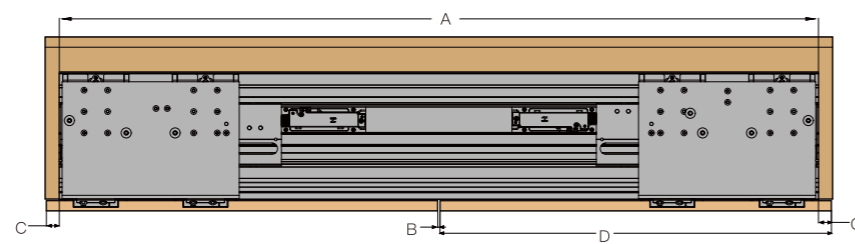

四门柜体参数图 Four doors cabinet parameters

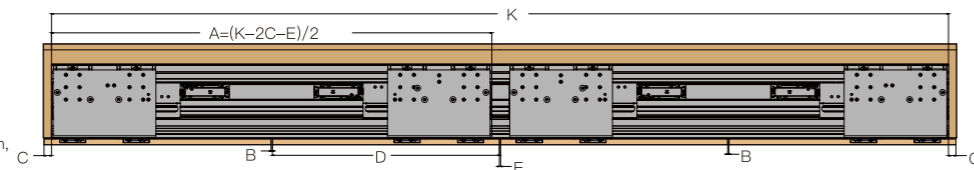

门板参数加工并安装配件
Install accessories in the door

产品规格 Product Specification	T803-2050	T803-2450	T803-2850	T803-1650
L	270	370	470	195

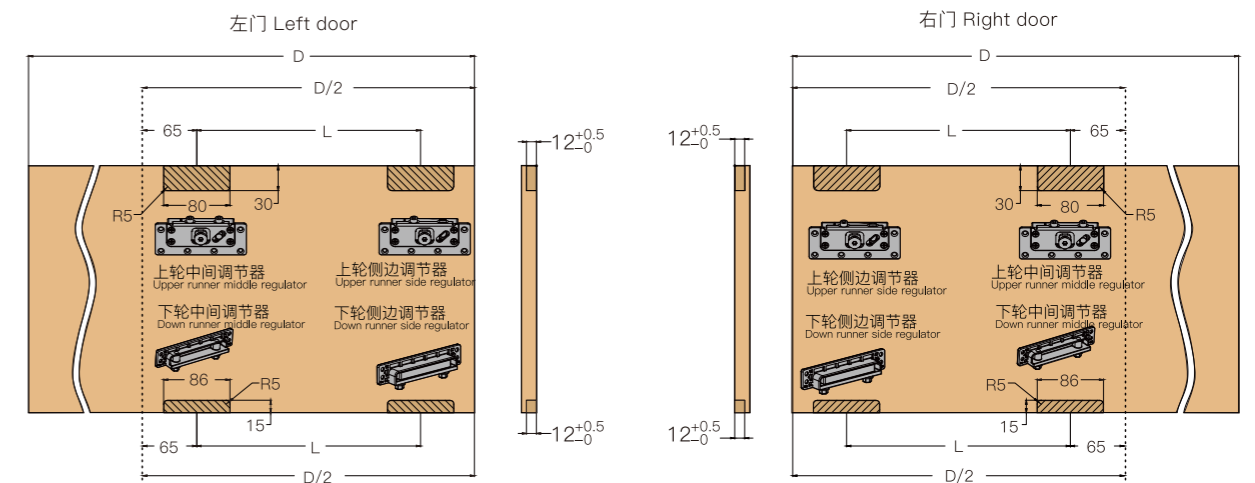

TD803

CUTTABLE ELECTRIC INLINE SLIDING DOOR SYSTEM

可裁切电动平趟门系统

专利结构，轨道可裁切；

搭载智能控制系统，无线控制门板开合；

闭合后在同一平面，整体美观、大气；

手动辅助开合功能，配置高，更省心；

遇障碍物时，触发防夹手功能，舒适更安心；

断电后，可手动推拉开合；

升级承重结构，适用18-45mm重型门板，单门承重达80Kg。

Patented product mechanism, The rail can be cuttable.

Intelligent electric control system. Wireless control door opening and closing.

Two doors close in one piece, neat looking.

Assistant function for manual opening and closing.

Anti-pinch function takes effect when there are obstacles.

Manual opening and closing is workable under power-off condition.

Upgraded loading capacity structure.

Apply to thickness of door: 18-45mm heavy door.

Loading capacity: 80kg per door.



配件名称 Accessories

数量 Qty

两门 2Doors 四门 4Doors

配件图 Drawing

配件名称 Accessories	数量 Qty	配件图 Drawing
	两门 2Doors 四门 4Doors	
T803上轨道组件 T803 Upper Rail	1 2	
T803下轨道组件 T803 Upper Rail	1 2	
T803上轮中间调节器 T803 Upper runner middle angle regulator	2 4	
T803上轮侧边调节器 T803 Upper runner side angle regulator	2 4	
T803下轮中间调节器 T803 Down runner middle angle regulator	2 4	
T803下轮侧边调节器 T803 Down runner side angle regulator	2 4	
15-8调节扳手 15-8 Spanner	1 1	
T803侧边加强拉簧 T803 Side Spring	2 4	
遥控器 Remote controller	1 1	
按压开关控制器 Press switch controller	2 4	
T803 驱动装置 T803 Driving device	1 2	
5芯航空线 (带5芯航空母插) 5-core aviation plug wire	1 3	
1.5米AC电源线 1.5 meter AC power cord	1 2	
4芯航空线 (带4芯航空母插) 4-core aviation plug wire	1 2	
TH00020橡胶垫 (φ20*2) Th00020 Spacer (φ20*2)	4 8	

产品型号及规格 Product specification

产品型号 Item code	适配标准柜体内宽 Cabinet standard inner width	轨道可裁切范围 Cutttable rail range	备注 Remark
TD803-2050	2050mm	1650mm--2050mm	长度按客户要求定制 Length according to customer requirements
TD803-2450	2450mm	2050mm--2450mm	长度按客户要求定制 Length according to customer requirements
TD803-2850	2850mm	2450mm--2850mm	长度按客户要求定制 Length according to customer requirements
TD803-1650	1650mm	1350mm--1650mm	长度按客户要求定制 Length according to customer requirements

安装参数详解 Specification

门板厚度含拉手≤45mm
Door Thickness ≤45mm (Handle included)

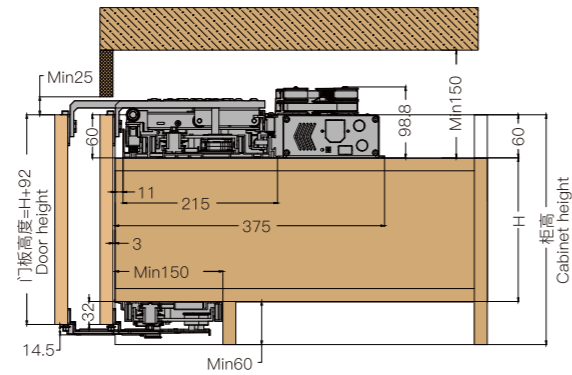

柜体要求 Cabinet requirements

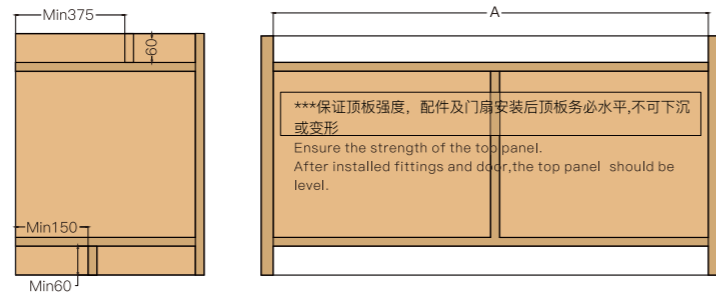

门板盖侧板
Door panel cover side panel

A=柜体内宽
B=门缝 (≥4mm)
C=门板盖侧边宽度(≤25mm)
D=门板宽度= (A+2C-B) /2

A=Inner width of cabinet
B=Gap between two doors(≥4mm)
C=Side panel width(≤25mm)
D=Door width=(A+2C-B)/2

A=单套产品长度
D=门板宽度= (K+2C-2B-E) /4
E=中间两门门缝
(两门不同时打开E≥3mm;两门同时打开E≥6mm)
K=四门柜体总内宽

***下单根据A值选择TD803中一款, 备注单套轨道长度K/2数值即可

A=Single product standard length
D=Door width=(K+2C-2B-E)/4
E=Gap between middle two doors
(two doors not open at same time,E≥3mm, two doors open at same time,E≥6mm)
K=Four door Inner width of cabinet

According to A value to choose the product length, remark Single rail lengths K/2

两门柜体参数图 Two doors cabinet parameters

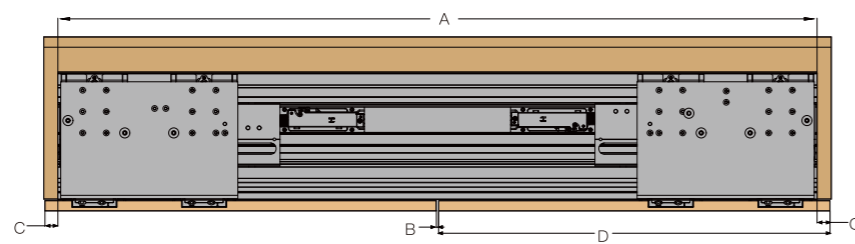

四门柜体参数图 Four doors cabinet parameters

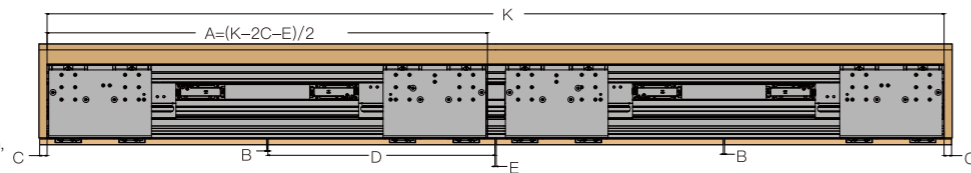

门板不盖侧板
Door panel not cover side panel

A=柜体内宽
B=门缝 (≥4mm)
C=门板盖侧边宽度(≤25mm)
D=门板宽度= (A-2C-B) /2

A=Inner width of cabinet
B=Gap between two doors(≥4mm)
C=Side panel width(≤25mm)
D=Door width=(A-2C-B)/2

A=标准产品长度
D=门板宽度= (K-2C-2B-E) /4
E=中间两门门缝
(两门不同时打开E≥3mm;两门同时打开E≥6mm)
K=四门柜体总内宽

***下单根据A值选择TD803中一款, 备注单套轨道长度K/2数值即可

A=Single product standard length
D=Door width=(K-2C-2B-E)/4
E=Gap between middle two doors
(two doors not open at same time,E≥3mm, two doors open at same time,E≥6mm)
K=Four door Inner width of cabinet

According to A value to choose the product length, remark Single rail lengths K/2

两门柜体参数图 Two doors cabinet parameters

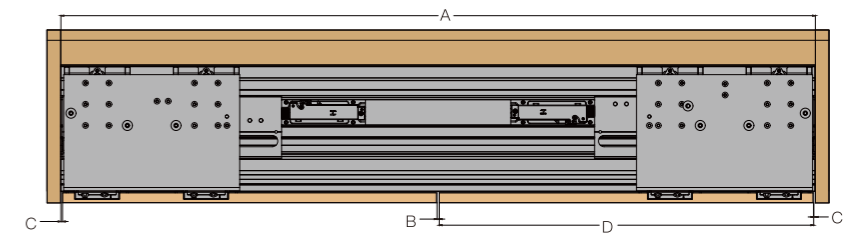

四门柜体参数图 Four doors cabinet parameters

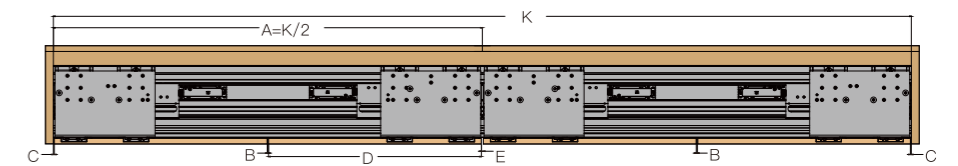

门板参数加工并安装配件
Install accessories in the door

产品规格 Product Specification	TD803-2050	TD803-2450	TD803-2850	TD803-1650
L	270	370	470	195

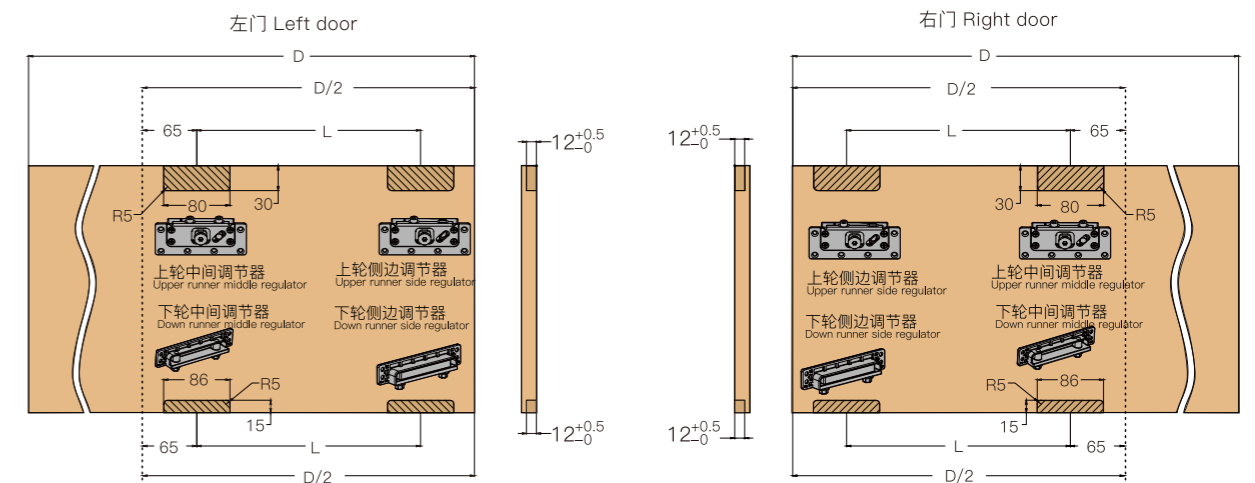

T902

FOLD-SLIDE SYSTEM 折叠平趟门系统

缓冲器带复位功能、防脱钩；

自动寻位设计，安装简便，具有高低可调节功能；

滑轮采用高强度轴承+进口POM材料，韧性高，耐磨，静音；

柜门关闭时采用阻尼系统，提高家具档次、延长家具寿命；

门板宽度300-600mm，单门承重20kg，门板厚度≥16mm。

Damper with Anti jumping and Anti-decoupling fuction;

Auto reset function, easy adjustment;

Imported POM material for wheel,

to achieve best silent performance and long lifespan;

Single door width 300-600mm, Single door loading capacity 20kg,

Single door thickness ≥16mm.



配件名称 Accessories	数量 Qty	配件图 Drawing
左上轮组件 Left upper roller	1	
左下轮组件 Left down roller	1	
T902塑料合页 T902 Plastic hinge	4	
8mm外六角调节扳手 8mm Spanner	1	
2mm六角匙 2mm Allen key	1	
右上轮组件 Right upper roller	1	
右下轮组件 Right down roller	1	
打孔模板 Position template	1	
309新型缓冲器轻型 Damper	2	
ST4*16 十字沉头自攻钉 Wooden screw	46	

不装顶柜 Without top cabinet

安装顶柜 With top cabinet

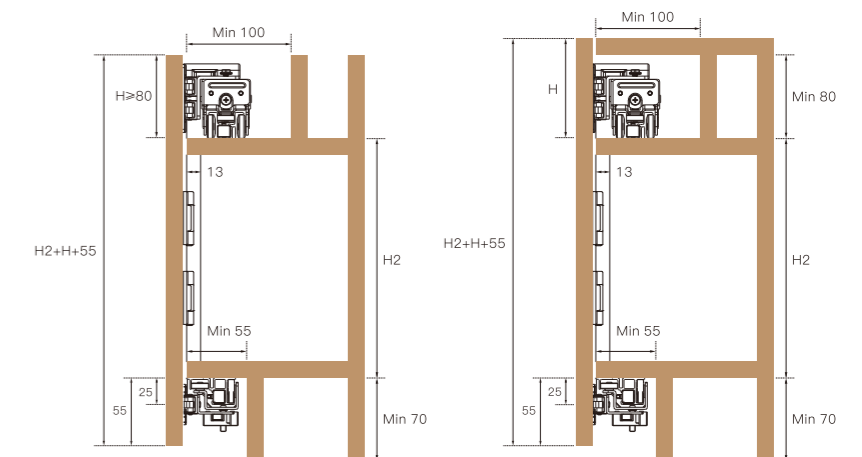

柜体尺寸参考 Cabinet size for reference

门板钻孔尺寸参考 (以二折叠为例):
A孔为合页孔, 钻Φ2.5 孔深0-2mm B孔为铰链孔, 钻Φ35 孔深12mm

Door preparation-Drilling dimension.
Hole A: plastic hinge hole, with dia 2.5mm and depth 0-2mm,
Hole B: steel hinge hole, with dia 35mm and depth 12mm

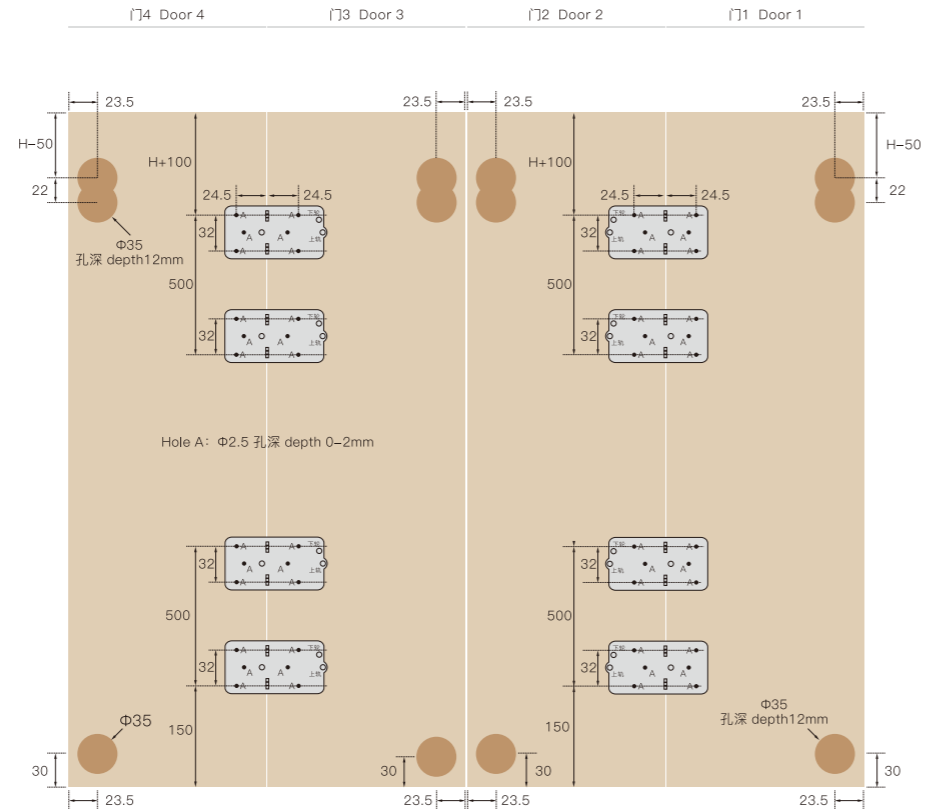

门板宽度300-600mm, 单门承重20kg, 门板厚度≥16mm
Single door width 300-600mm, Single door loading capacity 20kg,
Single door thickness ≥16mm.

$h = H_2 + H + 55$ 门板高度 Door height
 $W = (L - 2n + 2) / n$ 门板宽度 Door width
 $n =$ 门扇数量 Door's quantity

$H =$ 门板高出顶板尺寸 Door's height-top panel's height
 $F = 18\text{mm}$ 侧板 Side panel

一折叠 One fold

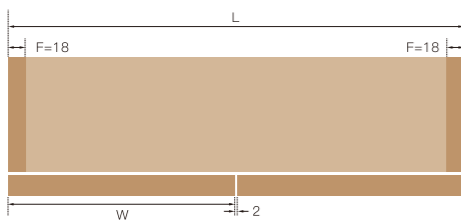

二折叠 Two folds

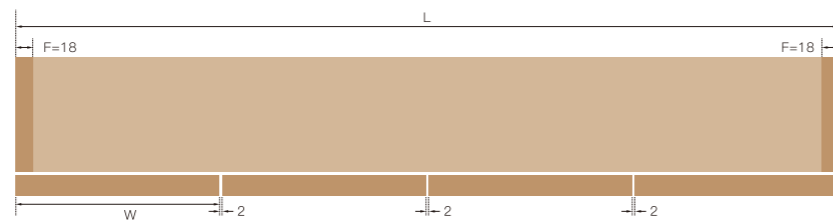

柜体要求 Cabinet Requirements

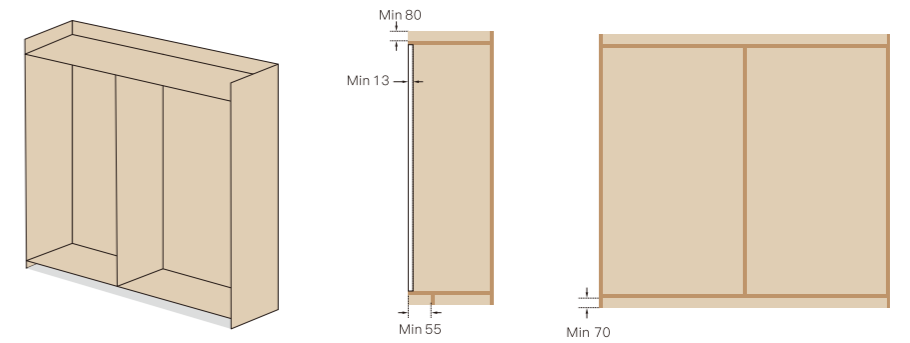

安装上下轨道预装配件 (注意配件方向)
Install accessories for up and down rails
(Pay attention to direction)

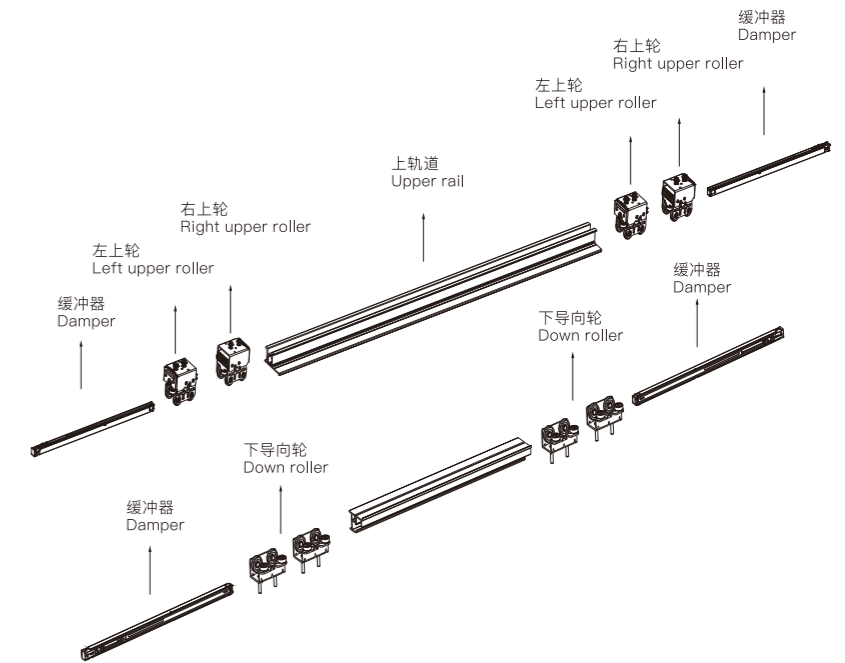

预钻上下轨道Φ5安装孔
Drill Φ5 holes for up and down rails

预钻上轨安装孔 Drill holes for upper rail

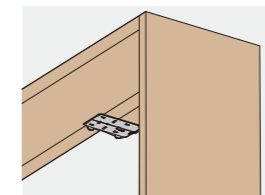

预钻下轨安装孔 Drill holes for down rail

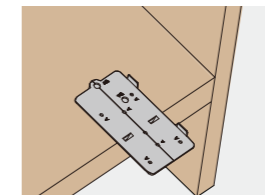

打孔示意图 Drilling Dimension

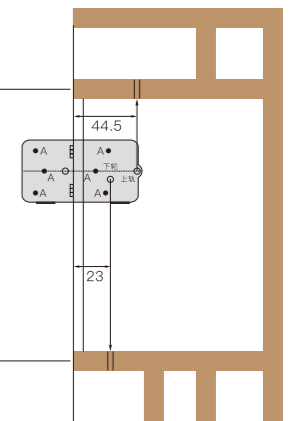

T909A

FOLD-SLIDE HANGING ROLLER SYSTEM 折叠吊轮系统

无下轨道，隐匿性强，单门最大承重15Kg；

配件采用快装可调节结构，不分左右，安装简便；

带阻尼缓冲效果，提升档次、延长家具寿命；

采用毛刷装置，自动清除轨道灰尘，保证运行顺畅静音；

最小门扇间距115mm，最小折叠夹角15°；

中竖板内缩仅30mm，关门最小缝隙2mm，柜体密封性更好；

开门不刮碰侧板，可做连体柜设计；

设有门停功能，开门可停靠固定；

门板厚度：18-25mm。

No down rail.Loading capacity 15kg per door.

Clip on with adjustment mechanism.

No distinguish for left and right accessories, easy installation.

Brush device for cleaning the dust on rail.

Smooth and silent performance.

Excellent space after folding: distance between doors≤115mm, folded angle ≤15°.

Only 30mm reserve space for median division board inside cabinet.









Minimum gap 2mm after door closing.

No collision between door and side panel when the door is opened.

Stopper for doors. Doors can stably stop after opening.

Door thickness: 18-25mm.



配件名称 Accessories	数量 Qty	配件图 Image
T909A 滑轮组件 T909A Upper rollers	1	
T909A 边折滑轮铰链组件 T909A Rollers and hinges for middle folding doors	1	
T909A 门停组件 T909A Stopper	1	
H94 直臂铰链组件 H94 Full overlay hinge	2	
T902合页 T902 Plastic hinge	2	
ST4*16十字沉头自攻钉 ST4*16 Wooden screw	30	
T902合页打孔模版 T902 Position template	1	
GD-214 折叠门上轨 GD-214 Upper rail of the fold slide door	1	

柜体尺寸参数 Cabinet size

门扇尺寸: 2扇折叠时, 门扇宽度不超过500mm,
门高不超过1200mm, 门厚18-25mm;

最大承重: 应用于2扇门时单门不超过15Kg;

Door size:

2-door folding: width≤500mm, height≤1200mm, thickness 18-25mm.

Loading capacity: 2-door folding: ≤15kg per door.

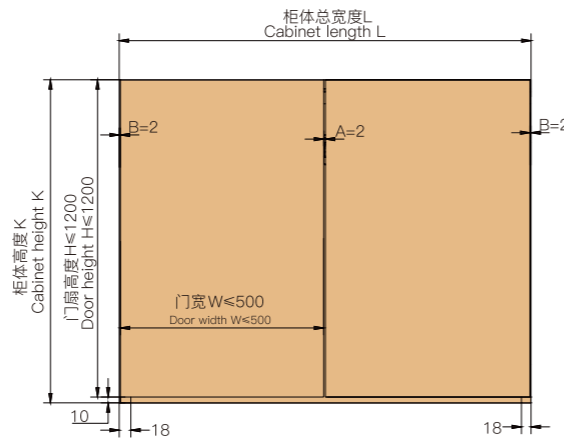

A:合页安装预留门缝2mm

B:柜体侧板与门扇侧边预留门缝2mm

门扇宽度: $W = \frac{L-6}{2} = \frac{(L-2-2*2)}{2}$, $W \leq 500\text{mm}$,
门板数量2

门扇高度: $H = K - 10$, $H \leq 1200\text{mm}$

中隔板内缩Min30mm, 底板隔板高Min65, 内缩Min75

A: Reserve 2mm gap for plastic hinge installation

B: Reserve 2mm gap between the cabinet side board and the door side.

Door width: $W = \frac{L-6}{2} = \frac{(L-2-2*2)}{2}$, $W \leq 500\text{mm}$,
Door qty 2

Door height: $H = K - 10$, $H \leq 1200\text{mm}$

Middle division board reserve space Min30mm,
bottom division board height Min 65mm,
bottom division board reserve Min 75mm

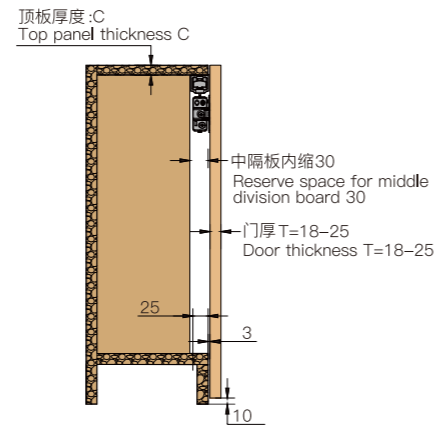

使用场景及安装图示 Application and Installation Instruction

该折叠系统可以应用于覆盖上板和侧板结构,
主要用于木质门结构, 或者铝质边框门扇。

This folding system can be used to cover top panel
and side panel of cabinet. Mainly apply to wooden
doors or aluminum frame doors.

两扇推拉折叠门示意图

Diagram for 2-door folding (fixing side door)

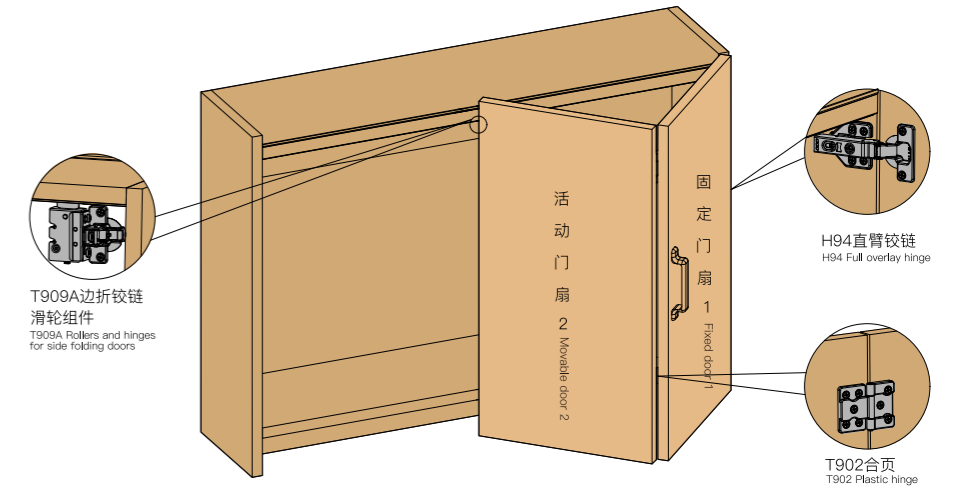

门扇开孔尺寸图 Dimension for drilling holes

C 为顶板厚度

⊕ 为φ35铰杯孔, 深12mm,
• 为合页预装孔 (打孔模板打A孔)

C: Top panel thickness

⊕ Dia 35mm hinge cup hole, depth 12mm
• Pre-drilling holes for plastic hinge
(A holes in drilling template)

门宽≤1200mm

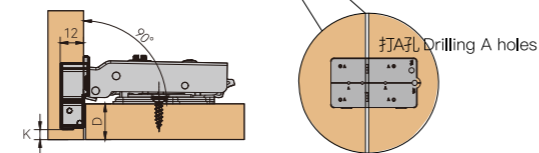
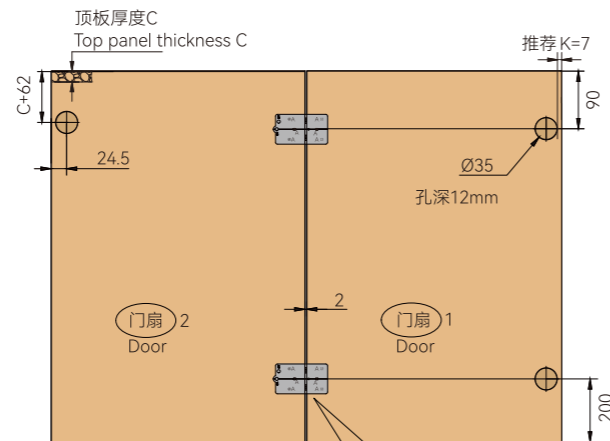

H94直臂铰链盖位对照表
Coverage calculation table

K	3	4	5	6	7	8
D	17	18	19	20	21	22

T909B

FOLD-SLIDE HANGING ROLLER SYSTEM

折叠吊轮系统

门板与滑轮连接采用快装结构，单门最大承重25Kg；

上下轮具有可调节功能，配件不分左右，安装简便；

带阻尼缓冲效果，提升档次、延长家具寿命；

采用毛刷装置，自动清除轨道灰尘，保证运行顺畅静音；

最小门扇间距115mm，最小折叠夹角15°；

中竖板内缩仅30mm，关门最小缝隙2mm，柜体密封性更好；

开门不刮碰侧板，可做连体柜设计；

设有门停功能，开门可停靠固定；

门板厚度：18-25mm。

Clip on mechanism for connection between door and rollers.

Loading capacity 25kg per door.

Adjustment on both upper and down rollers.

No distinguish for left and right accessories. Easy installation.

Brush device for cleaning the dust on rail.

Smooth and silent performance.

Excellent space after folding: distance between doors<115mm,

folded angle <15°.

Only 30mm reserve space for median division board inside cabinet.

Minimum gap 2mm after door closing.

No collision between door and side panel when the door is opened.

Stopper for doors. Doors can stably stop after opening.

Door thickness: 18-25mm.



配件名称 Accessories

数量 Qty

配件图 Image

1600-2400mm

2400-2600mm

T909B滑轮组件 T909B Upper rollers

1

1



T909B边折滑轮铰链组件

T909B Rollers and hinges for side folding doors

1

1



T909B边折下滑轮组件

T909B Down rollers for side folding doors

1

1



T909A门停组件 T909A Stopper

1

1



H94直臂铰链组件

H94 Full overlay soft closing hinge

4

4



T902合页 T902 Plastic hinge

4

6



H94直臂铰无缓冲链组件

H94 Full overlay non-soft closing hinge

0

3



10*1.5半球形自粘脚垫(3M)

10*1.5 arch self-adhesive pad

4

4



ST4*16十字沉头自攻钉 ST4*16 Wooden screw

62

88



T902合页打孔模版 T902 Position template

1

1



GD-214 折叠门上轨

GD-214 Upper rail of the fold slide door

1

1



GD-205 折叠门下轨

GD-205 Down rail of the fold slide door

1

1



柜体尺寸参数 Cabinet size

门扇尺寸: 2扇折叠时, 门扇宽度不超过600mm,
门高不超过2600mm, 门厚18-25mm;

最大承重: 应用于2扇门时单门不超过25Kg;

Door size:
2-door folding: width≤600mm, height≤2600mm, thickness 18-25mm.

Loading capacity: 2-door folding: ≤25kg per door.

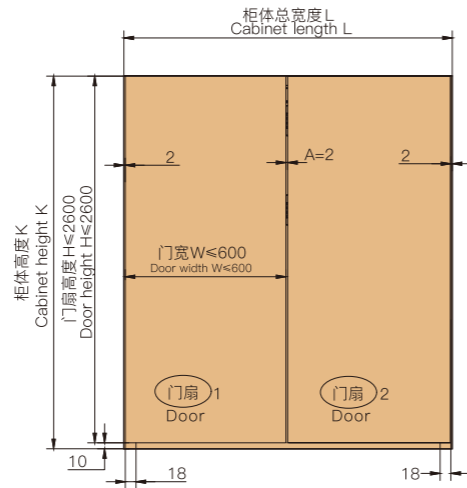

- A:合页安装预留门缝2mm
- B:柜体侧板与门扇侧边预留门缝2mm
- 门扇宽度: $W = \frac{L-6}{2} = \frac{(L-2-2*2)}{2}$, $W \leq 600\text{mm}$,
- 门扇高度: $H = K - 10$, $H \leq 2600\text{mm}$
- 中隔板内缩Min30mm, 底板隔板高Min65, 内缩Min75

- A:Reserve 2mm gap for plastic hinge installation
- B:Reserve 2mm gap between the cabinet side board and the door side.

Door width: $W = \frac{L-6}{2} = \frac{(L-2-2*2)}{2}$, $W \leq 600\text{mm}$,

Door height: $H = K - 10$, $H \leq 2600\text{mm}$

Middle division board reserve space Min30mm,
bottom division board height Min 65mm,
bottom division board reserve Min 75mm

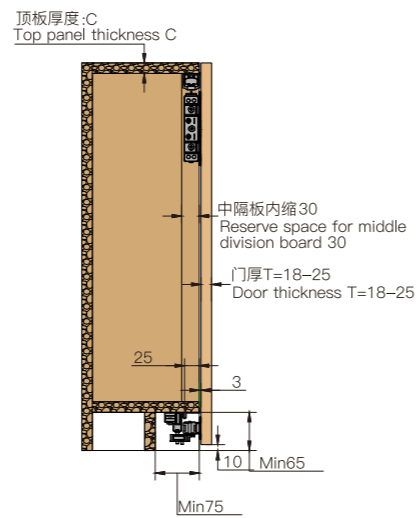

门扇开孔尺寸图 Dimension for drilling holes

- C 为顶板厚度
- ⊕ 为φ35铰杯孔, 深12mm,
- 为合页预装孔 (打孔模板打A孔)
- C: Top panel thickness
- ⊕ Dia 35mm hinge cup hole, depth 12mm
- Pre-drilling holes for plastic hinge (A holes in drilling template)

1600≤门高 Door height H≤2400mm

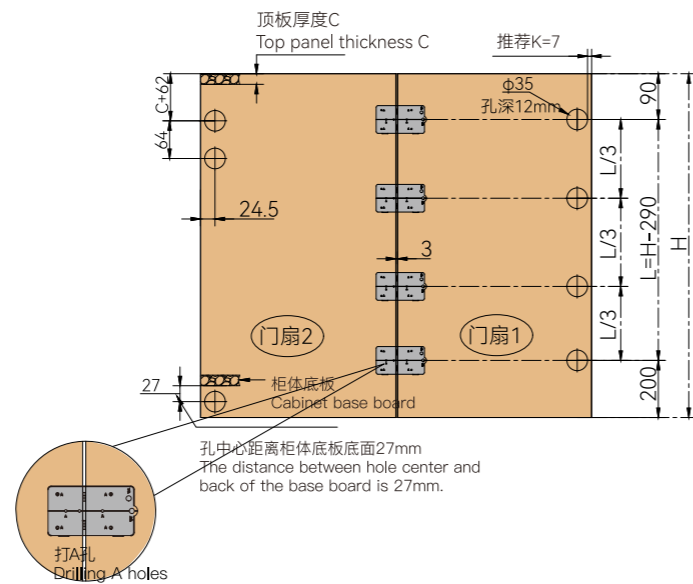

门高 Door height 2400-2600mm

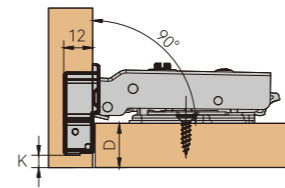

H94直臂铰链盖位对照表
Coverage calculation table

K	3	4	5	6	7	8
D	17	18	19	20	21	22

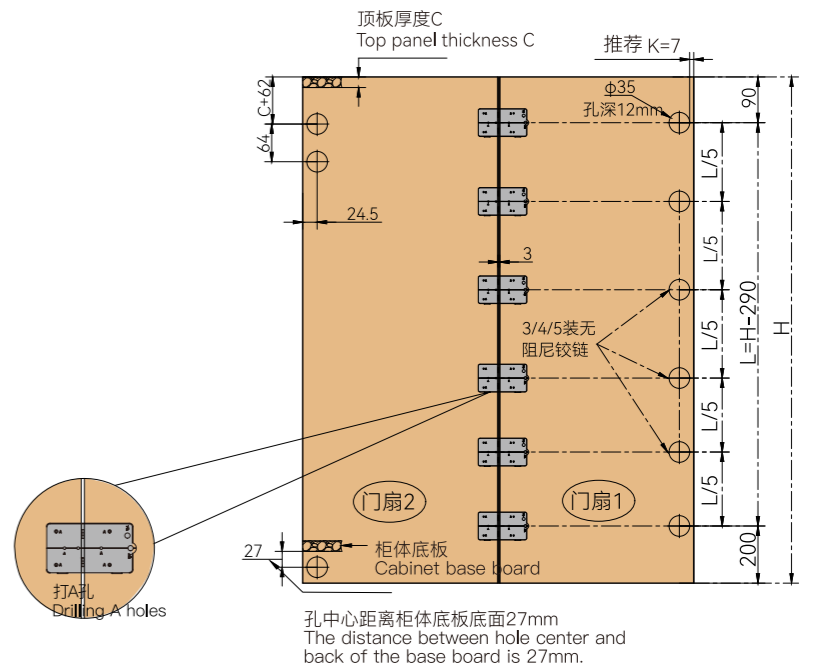

使用场景及安装图示 Application and Installation Instruction

该折叠系统可以应用于覆盖上板和侧板结构, 主要用于木质门结构, 或者铝质边框门扇。
This folding system can be used to cover top panel and side panel of cabinet. Mainly apply to wooden doors or aluminum frame doors.

两扇推拉折叠门示意图
Diagram for 2-door folding(fixing side door)

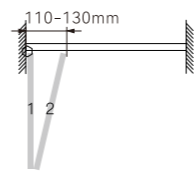

门板厚度 Door thickness 18, 110
门板厚度 Door thickness 25, 130

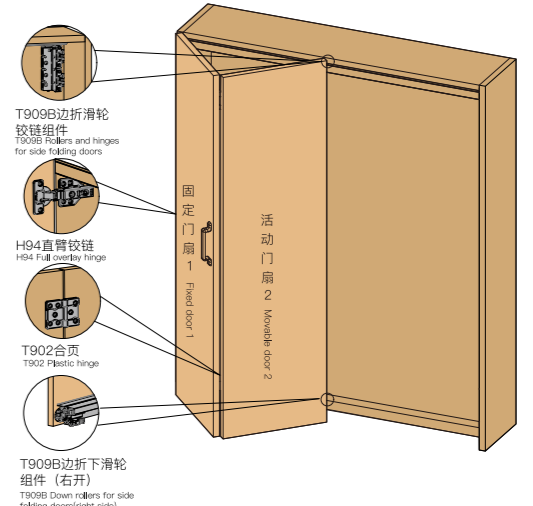

下轮左右更换说明:
Instruction for switching left and right rollers:

T909B边折下滑轮组件 (右开)
T909B Down rollers (right side open)

- 1、T909B边折下滑轮组件, 当前L字标朝上开门方向为左侧
- 2、松开两个M4机丝, 将铰链旋转180度, 让R面朝上。
- 3、对齐孔位, 用配件包长螺丝锁紧。
- 4、R字标朝上为门方向为右侧

T309

CONCEALED SLIDING DOOR SYSTEM

隐藏型--内推智慧系列





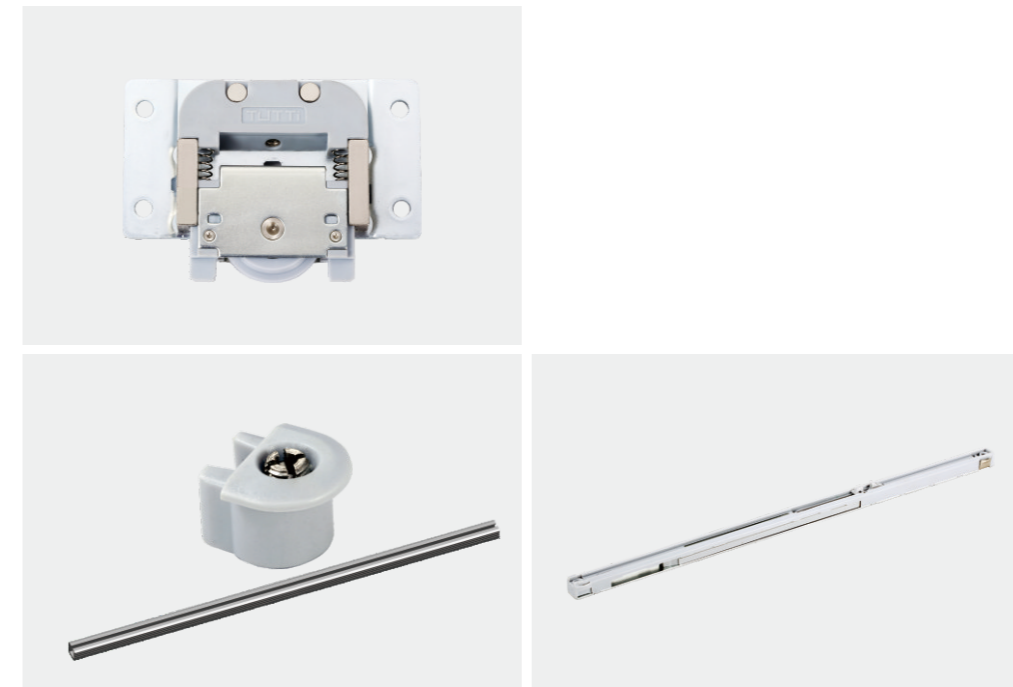

专利产品:

18mm顶板内藏阻尼, 阻尼自动定位功能;
 极其舒适安全的缓冲效果, 提高家具档次、延长家具寿命;
 滑轮采用高强度轴承+进口POM材料, 韧性高、耐磨、静音;
 自动寻位设计, 安装简便, 具有高低可调节功能;
 缓冲器带复位功能、防跳、防脱钩;
 可选配上下左右四路缓冲, 以及上方或下方双向缓冲;
 适用于板式、实木的成品或定制家具, 单扇门重要求: 10-50kg,
 单扇门尺寸要求: 500mm≤门宽≤1200mm, 高度≤2500mm。

Patented product;

Concealed damper in minimum 18mm top panel;
 Imported POM material for wheel,
 to achieve best silent performance and long lifespan;
 Auto reset function, easy adjustment;
 Damper with Anti jump and Anti-decoupling function;
 Single door weight requirement: 10-50kg;
 Apply to thickness of wooden door: T≤20mm;
 Apply to thickness of Alum Frame door: T≤34mm;
 Single door size requirement: width 500-1200mm, height≤2500mm.



配件名称 Accessories	数量 Qty			配件图 Drawing
	二门 2 Doors	三门 3 Doors	四门 4 Doors	
滑轮 Runner	8	12	16	
缓冲器 Damper	4	4	4	
铝轨道堵头 Cap for Alum. rail ending	8	8	8	
铝轨道 Aluminum rail	4	4	4	
六角匙 Allen key	1	1	1	
ST4*16十字沉头自攻钉 ST4*16 Cross recessed countersunk head tapping screws	32	48	64	

门板铣槽图 Slot on door panel
安装滑轮 Runner installation

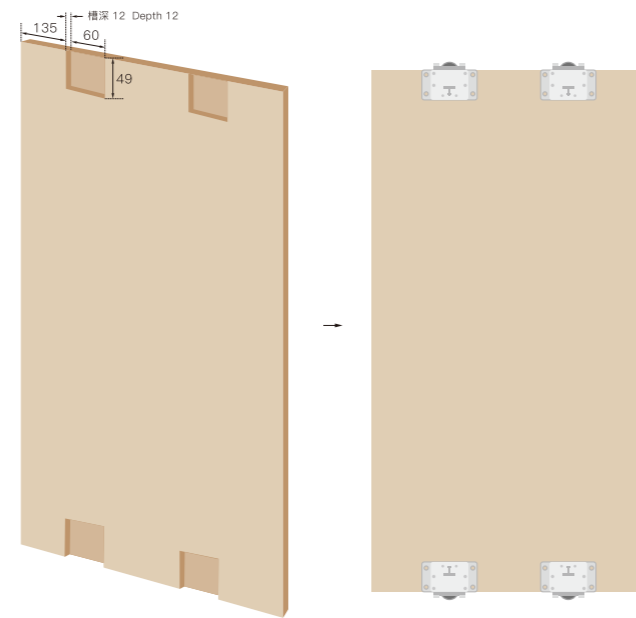

门与柜体尺寸关系 Wardrobe dimension
轨道铣槽图 Slot dimension for aluminum rail

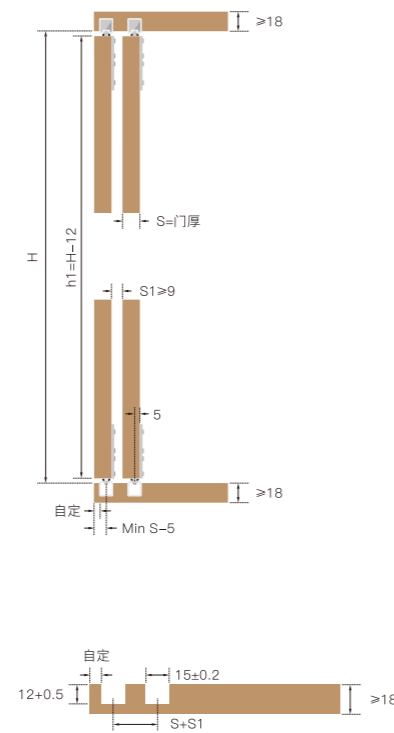

装入缓冲器和堵头 Damper installation



T409







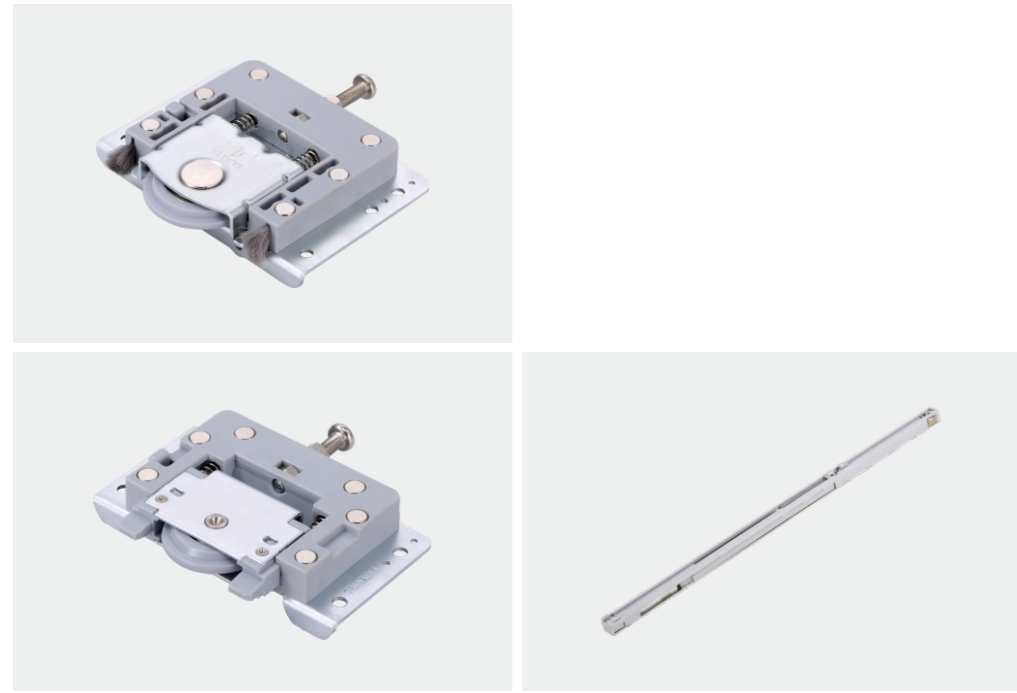

EXTERNAL SLIDING DOOR SYSTEM 明轮型--内推智慧系列

专利产品：
创新明轮结构，轨道及滑轮均无需开槽，安装简便；
隐藏式阻尼，阻尼自动定位功能；
板式、实木、铝框门家具专用；
安全舒适，静音顺滑，提高家具档次和寿命；
阻尼器有防跳功能，防脱钩功能（即自动挂钩功能），
单扇门重要求：10-50kg；门板厚度≤20mm；
单扇门尺寸要求：500mm≤门宽≤1200mm，高度≤2500mm。

Patented product;
External installation, no cutting or grooving needed;
Concealed damper with re-set function;
Damper with Anti jump and Anti-decoupling function;
Single door weight requirement: 10-50kg;
Single door size requirement:
Thickness≤20mm;
width 500-1200mm, height≤2500mm.





配件名称 Accessories	数量 Qty	二门 2 Doors	三门 3 Doors	配件图 Drawing
上滑轮 Upper runner	4	6		
下滑轮 Down runner	4	6		
六角匙 Allen key	1	1		
上轨道 Upper rail	1	1		
下轨道 Down rail	1	1		
下轨道装饰盖 Decoration cap for down track	1	1		
滑轮螺孔小垫块 Spacer	8	12		
缓冲器 Damper	4	4		
ST4*14十字大扁头自攻钉 ST4*14 Cross flat head self tapping screws	32	48		

木门安装 Installation guide for wooden door

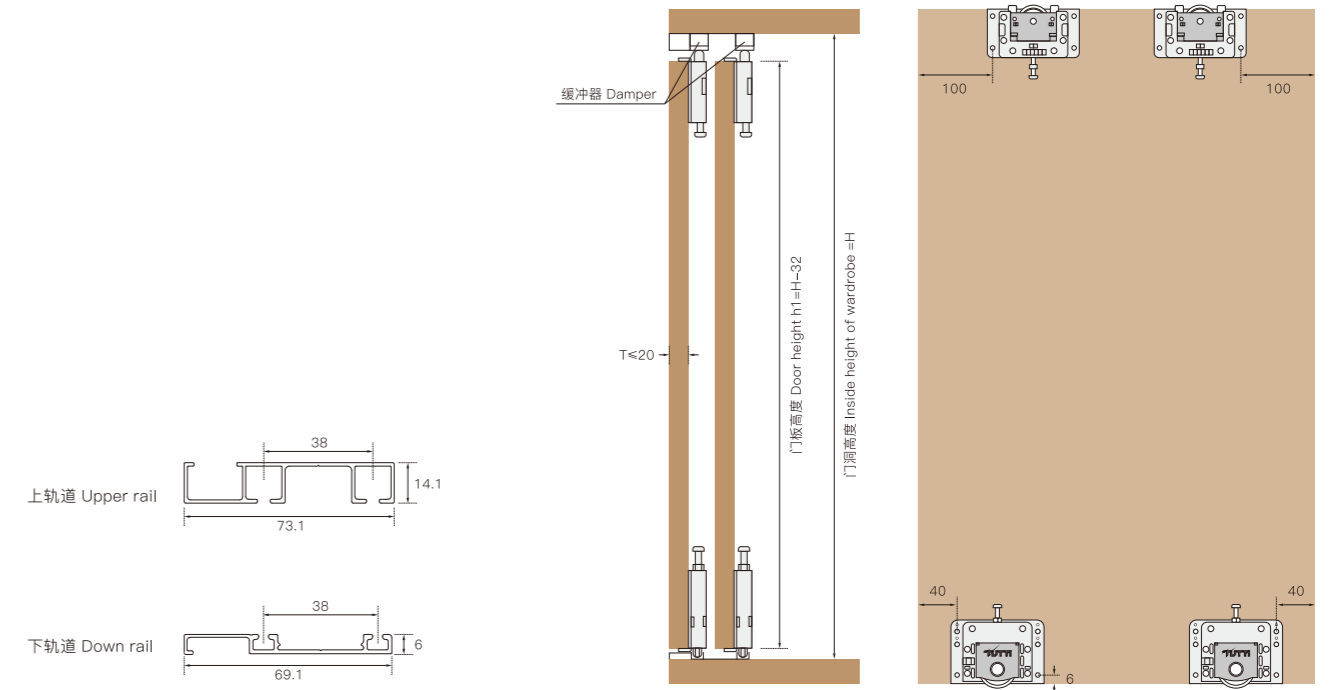

铝框门安装 Installation guide for aluminum frame door

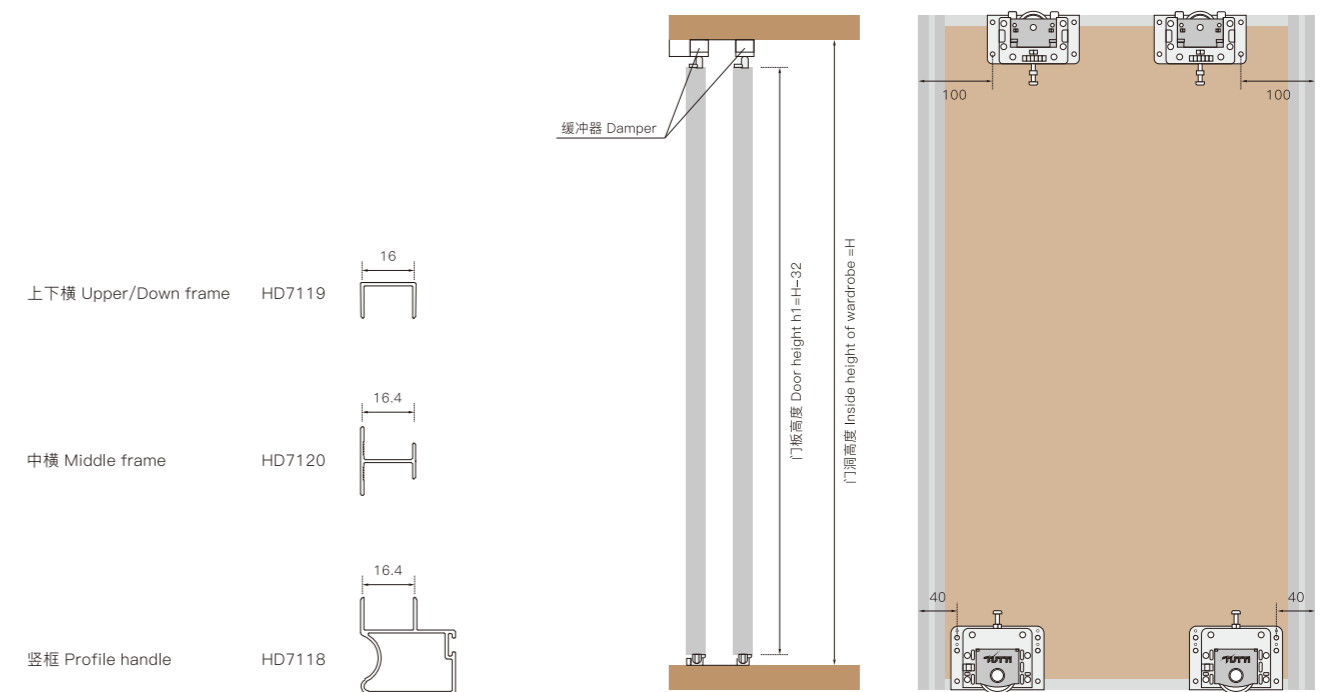

T306

UNIVERSAL SLIDING DOOR SYSTEM

经典型--内推智慧系列

专利产品：

极其舒适安全的缓冲效果，提高家具档次、延长家具寿命；
 滑轮采用高强度轴承+德国POM材料，韧性高、耐磨、静音；
 轨道滑轮行走面采用毛刷结构，自动清除轨道灰尘，运行顺畅、静音；
 阻尼器有防跳、防脱钩功能（即自动挂钩）；
 适用于板式、实木、玻璃等重型移门，单扇门重要求：10-60kg；
 适应门厚度：18-32mm，
 单扇门尺寸要求：500mm≤门宽≤1200mm，高度≤2500mm。

Patented product;

Imported POM material for wheel, to achieve best silent performance and long lifespan;
 Brush on runners, smooth and silent;
 Damper with Anti jump and Anti-decoupling function;
 Apply to thickness of wooden door: 18-32mm
 Apply to solid wood, panel wood and glass door;
 Single door weight requirement: 10-60kg,
 Single door size requirement: width 500-1200mm, height≤2500mm.



配件名称 Accessories	数量 Qty	二门 2 Doors	三门 3 Doors	配件图 Drawing
左上门滑轮 Left upper runner		2	3	
右上门滑轮 Right upper runner		2	3	
下门滑轮 Down runner		4	6	
阻尼器 Damper		4	4	
上轨道 Upper rail		1	1	
下轨道 Down rail		1	1	
六角匙 Allen key		1	1	
4*14十字盘头自攻钉 4*14 Cross pan head tapping screws		12	18	
4*30十字沉头自攻钉 4*30 Cross countersunk head tapping screws		8	8	
4*16十字沉头自攻钉 4*16 Cross countersunk head tapping screws		16	24	

安装参数 Installation

上铝轨道 Upper rail

下铝轨道 Down rail

订货号 (Item No.) T306-20
门厚 Door Thickness: 18mm≤T≤21mm

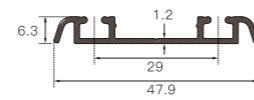
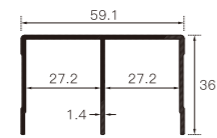

订货号 (Item No.) T306-25
门厚 Door Thickness: 21mm≤T≤25mm

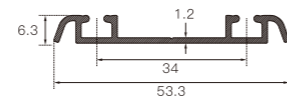
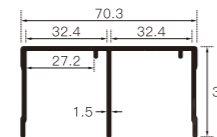

订货号 (Item No.) T306-32
门厚 Door Thickness: 25mm≤T≤32mm

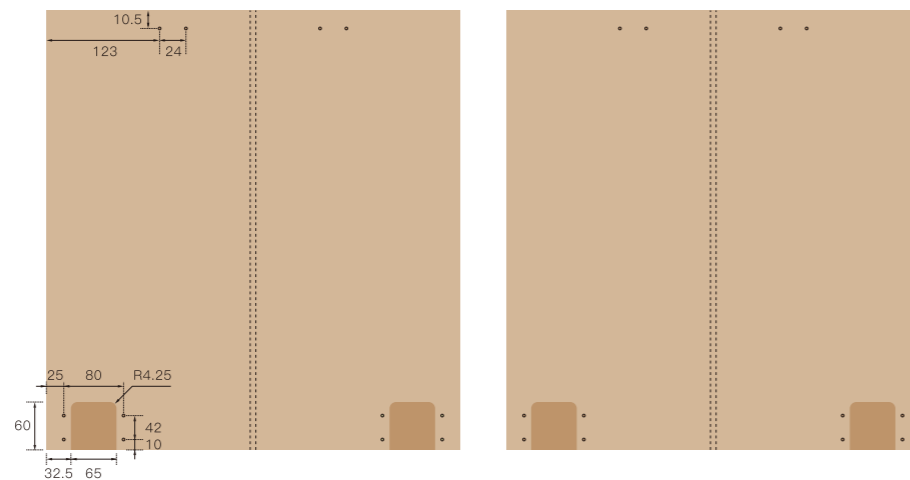
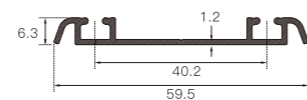
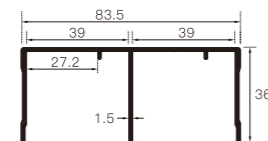

订货号 (Item No.) T306-20
适用18mm≤门厚≤21mm
18mm≤Door thickness≤21mm

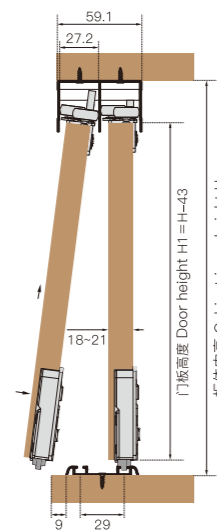

订货号 (Item No.) T306-25
适用21mm≤门厚≤25mm
21mm≤Door thickness≤25mm

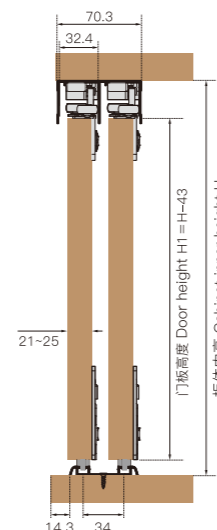

订货号 (Item No.) T306-32
适用25mm≤门厚≤32mm
25mm≤Door thickness≤32mm

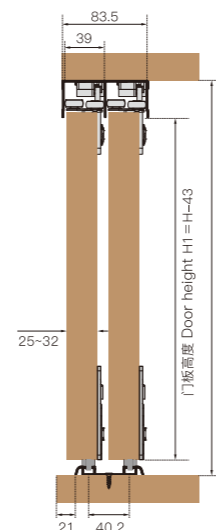

注: 轨道有箭头朝向柜体外侧
Pay attention to the installation
direction of the rail

T406

EXTERNAL SLIDING DOOR SYSTEM 明轮型--内推智慧系列

专利产品:

创新明轮结构, 轨道及滑轮无需开槽, 安装简便;

重型的板式、实木、铝框门家具专用;

安全舒适, 静音顺滑, 提高家具档次和寿命;

阻尼器有防跳功能, 防脱钩功能 (即自动挂钩);

滑轮采用高强度轴承+德国POM材料, 韧性高、耐磨、静音;

单扇门重: 10-60kg;

适应门厚度: T406-20木门≤20mm, 铝框门≤34mm,

T406-25木门≤25mm;

单扇门尺寸要求: 500mm≤门宽≤1200mm, 高度≤2500mm。

Patented product;

External installation, no cutting or grooving needed;

Damper with Anti jump and Anti-decoupling function;

Imported POM material for wheel, to achieve best silent performance and long lifespan;

Single door weight requirement: 10-60kg;

Apply to thickness of door: T406-20 wooden door≤20mm;

Alum frame door≤34mm; T406-25 wooden door≤25mm;

Apply to heavy panel wood, solid wood and aluminum frame door;

Single door size requirement: width 500-1200mm, height≤2500mm.





配件名称 Accessories

数量 Qty 二门 2 Doors 三门 3 Doors

配件图 Drawing

左上门滑轮 Left upper runner

2 3



右上门滑轮 Right upper runner

2 3



下门滑轮 Down runner

4 6



阻尼器 Damper

4 4



上轨道 Upper rail

1 1



下轨道 Down rail

1 1



滑轮螺孔小垫块 Spacer

8 12



ST3.5*13十字盘头铰尾钉
ST3.5*13 Cross recessed pan head tapping screws

32 48



4*30十字沉头自攻钉
4*30 Cross countersunk head tapping screws

8 8



安装参数 Installation

订货号 (Item No.) T306-32
门厚 Door Thickness: 16mm≤T≤20mm

订货号 (Item No.) T406-25
门厚 Door Thickness: 20mm≤T≤25mm

上铝轨道 Upper rail

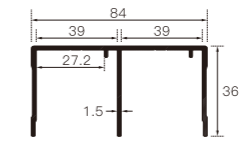

下铝轨道 Down rail

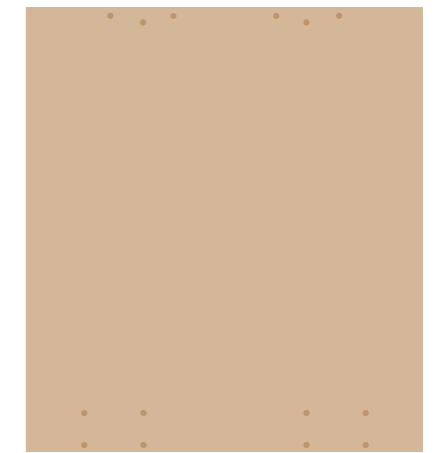
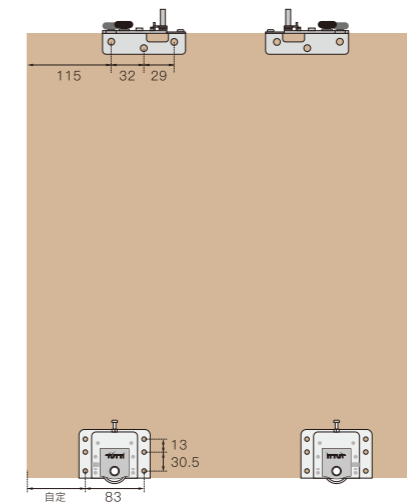
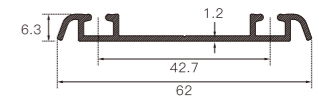
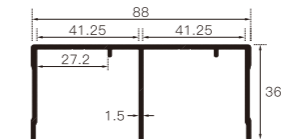
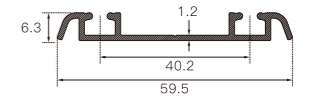

订货号 (Item No.) T406-25
适用木门
Apply to wood door only

铝框门
Aluminum frame door

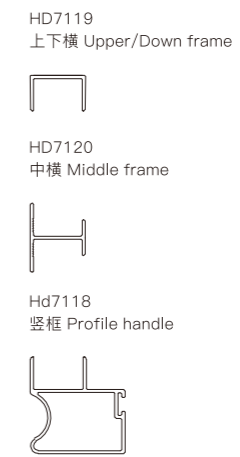
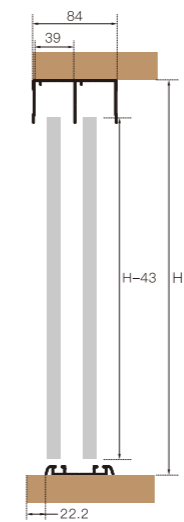

木门
Wood door

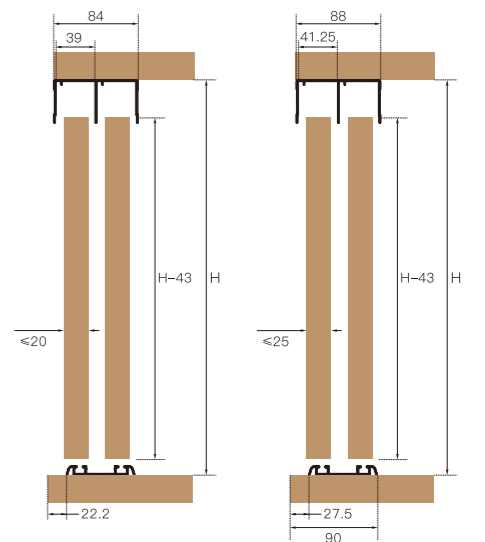

注: 轨道有筋位朝向柜体外侧
Pay attention to the installation direction of the rail

下轮安装于铝框门时需装入小垫块

T413

WOODEN DOOR SLIDING SYSTEM

厚门型--内推智慧系列

阻尼器档件双轮设计, 防跳效果好, 增加防跳上滑轮, 专业防跳;
 阻尼器增设特殊软胶结构, 升级静音效果;
 创新设计弹性端口装置, 齿轮联动, 使滑轮自动贴合轨道, 运行更平稳;
 阻尼器档件采用螺丝刀一键调节, 彻底摒弃传统六角匙调节的不便;
 单门承重50kg, 适用门厚25~32mm;
 最轻门重要求: 10kg;
 单扇门尺寸要求: 500mm≤门宽≤1200mm, 高度≤2500mm。

Anti Jumping Runners,
 Upgraded silent performance with special soft rubber on damper;
 With Creative Design Of Flexible Port And Toothed Gearing,
 The Runner Can Move Steadily And Smoothly On The Rail;
 Damper activator adjust by screw driver for most easy regulation;
 Loading capacity 50kg, Apply for thickness of door: 25~32mm;
 Min. door weight: 10kg;
 Single door size requirement: width 500~1200mm, height≤2500mm.

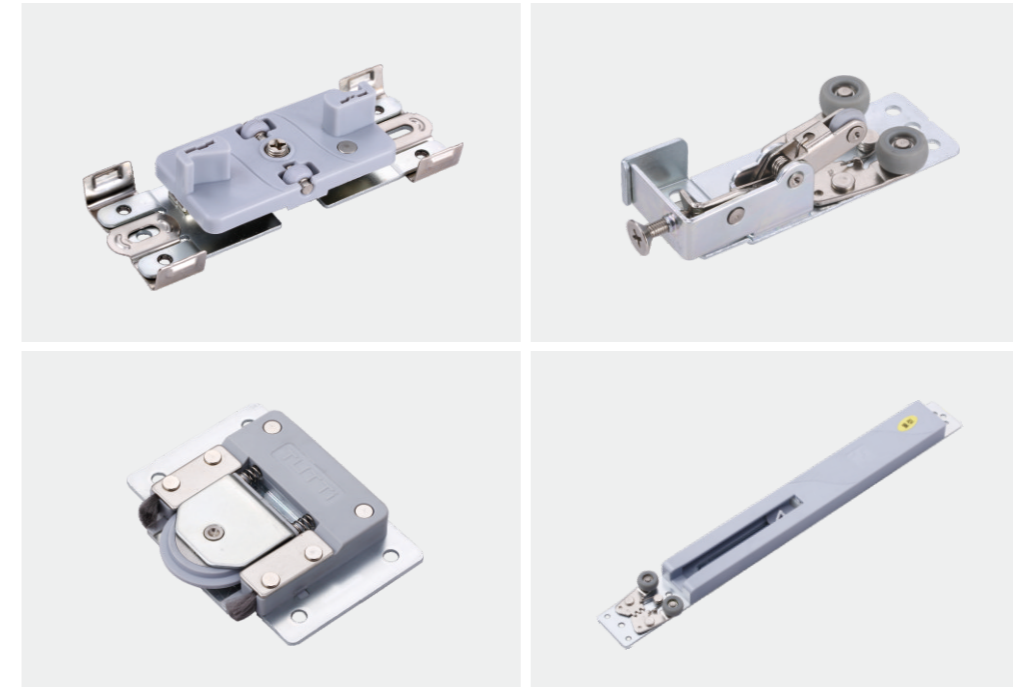

配件名称 Accessories	数量 Qty	二门 2 Doors	三门 3 Doors	配件图 Drawing
下滑轮 Down runner		4	6	
防跳上滑轮 Anti-jumping upper runner		0	2	
上滑轮缓冲器 Upper runner damper		4	4	
缓冲器挡件 Damper stopper		4	4	
上轨道 Upper rail		1	1	
下轨道 Down rail		1	1	
4mm六角匙 4mm Allen key		1	1	
ST4*20 铣尾螺丝 ST4*20 Milling tail screws		8	8	
ST4*16 十字沉头自攻钉 ST4*16 Cross countersunk head tapping screws		16	24	
ST4*24 大扁头自攻钉 ST4*24 Cross flat head self tapping screws		8	12	

安装参数 Installation

订货号 (Item No.) T413-TH-375
 订货号 (Item No.) T413-TH-390
 重型 Heavy damper
 适用于25-50kg Apply to 25-50kg

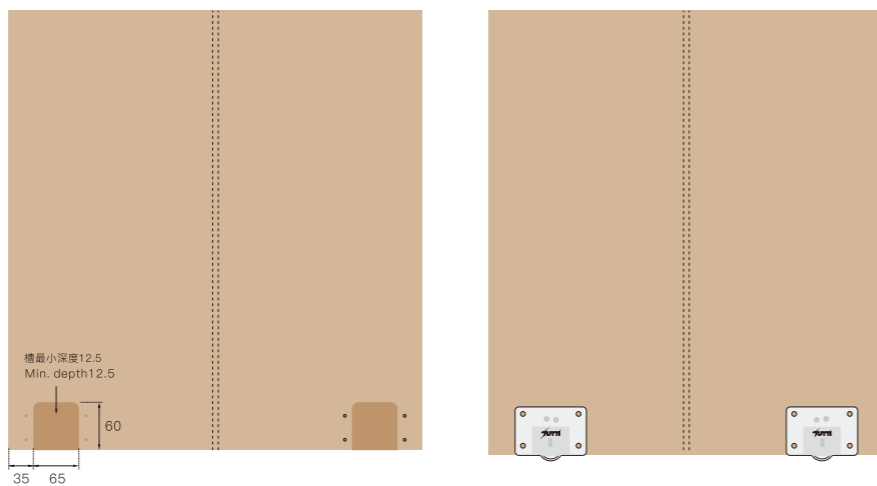
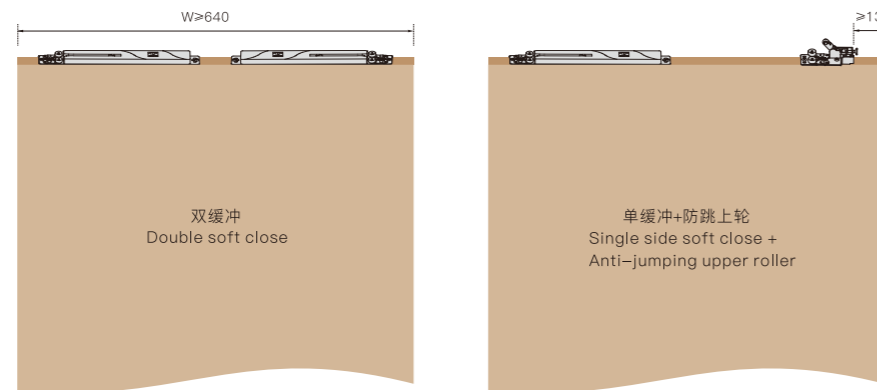

H=门洞/柜体内高 Inner height of wardrobe
 W=门宽 Door width, 608mm=2个缓冲器长度 Length of two dampers
 h1=门高 Door height
 S=门折厚度 Door thickness
 T=下轨高度 Height of down rail
 X=上下轨偏位 Off position of upper and down rail

T>6时, $h1 = H - 43 - (T - 6)$
 If T>6, then $h1 = H - 43 - (T - 6)$

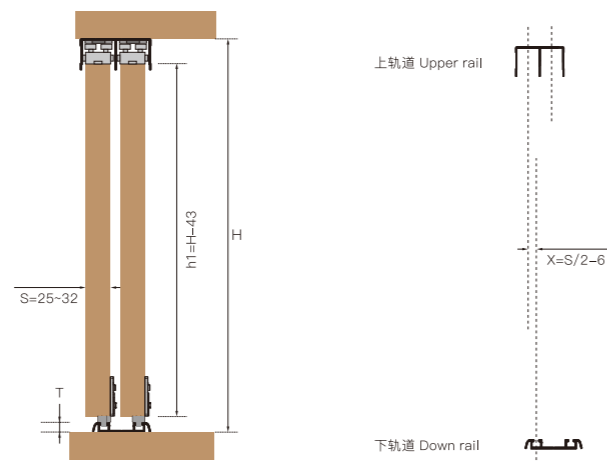

T408D

ALUMINUM FRAME DOOR SLIDING SYSTEM 铝框专属型--内推智慧系列

独特的弹性滑轮设计, 完美贴合轨道滑动顺畅;
 静音、安装简便、调试简单;
 铝框门专用移门缓冲系统, 单门承重5-50kg;
 门板厚度不超过35mm;
 防跳、防脱钩, 自动复位设计;
 408B独特专利上轮设计, 更舒适安全的缓冲效果, 提高家具档次与寿命;
 单缓冲: 400<门宽<1200, 高度<2500;
 双缓冲: 650<门宽<1200, 高度<2500.

Patented Anti Jumping Runners;
 Silence, easy installation, easy regulation;
 Apply for aluminum frame door;
 Automatic hook and re-set function;
 Single door loading capacity: 5-50kg;
 Apply for aluminum frame door thickness up to 35mm;
 Single door size
 Requirement: single soft closing: width 400~1200mm, height<2500mm,
 double soft closing width 650~1200mm, height<2500mm.



T408D

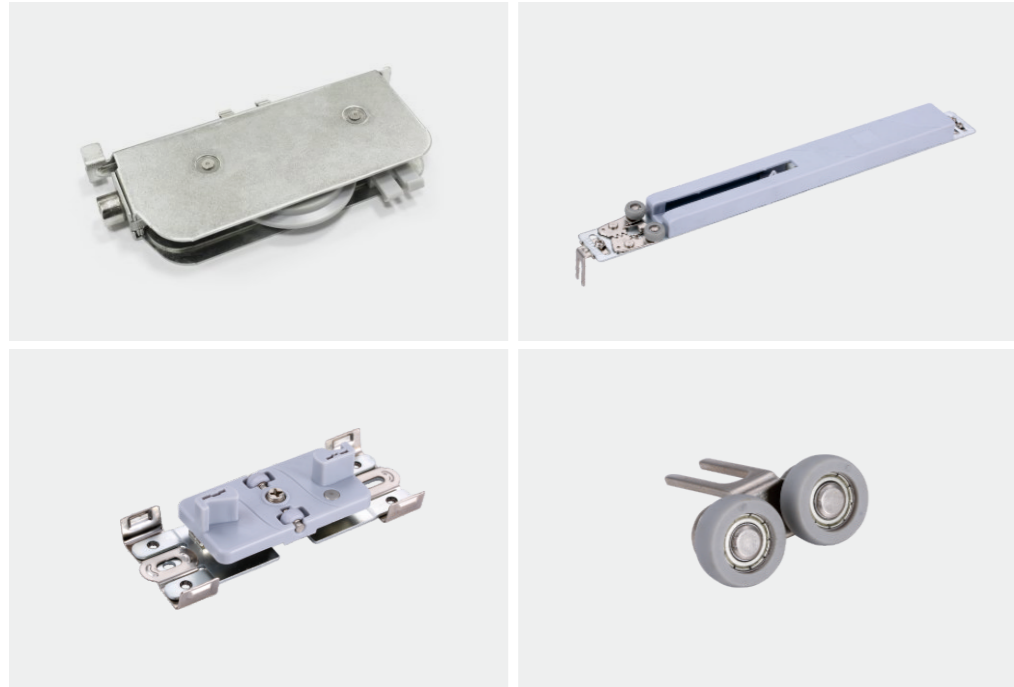

安装参数 Installation

门洞与门高尺寸要求
Required dimension of door height and cabinet height.
适用门宽
Suitable for door width.

T为下轨高度, 若 $T > 6$
 $h1 = H - 43 - (T - 6)$
T = Height of down rail, if $T > 6$
 $h1 = H - 43 - (T - 6)$

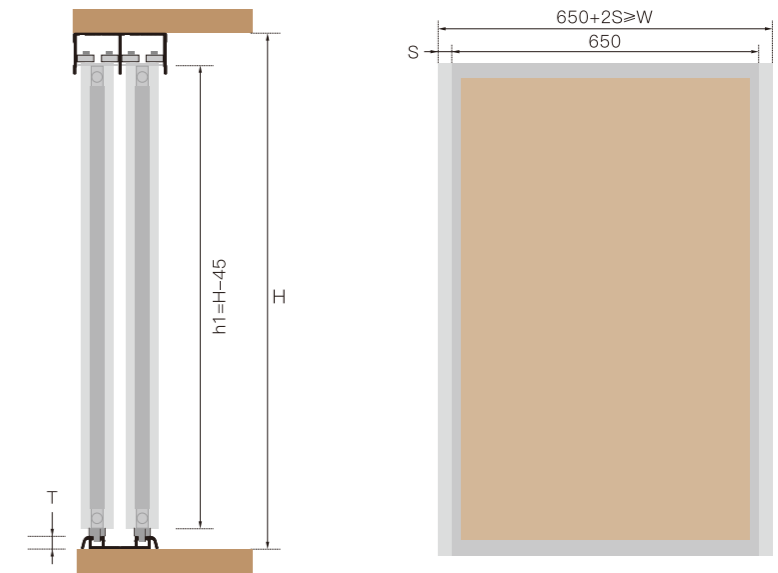

配件名称 Accessories	数量 Qty	双缓冲(两门用量) Double soft close (Two door)	双缓冲(三门用量) Double soft close (three door)	配件图 Drawing
上滑轮 Upper runner	0	2		
下滑轮 Down runner	4	6		
T形塑料件 T shape plastic part	4	4		
T408缓冲器 Damper	4	4		
缓冲器挡件 Damper stopper	4	4		
上轨道 Upper rail	1	1		
下轨道 Down rail	1	1		

订购说明 Ordering instruction

订货号 Item No.	T408D-TL-390 T408D-TL-375	轻型(15kg以下) Light damper (Less than 15kg)
订货号 Item No.	T408D-TM-390 T408D-TM-375	通用型(15~25kg) Standard damper (15~25kg)
订货号 Item No.	T408D-TH-390 T408D-TH-375	重型(25~50kg) Heavy damper (25~50kg)

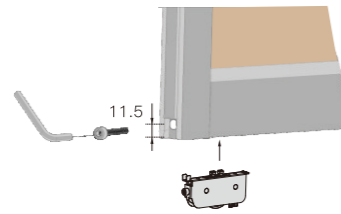

滑轮安装 Runner installation

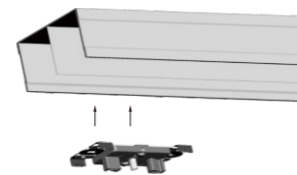

挡件安装 Stopper installation

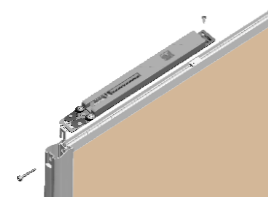

缓冲器安装 Damper installation

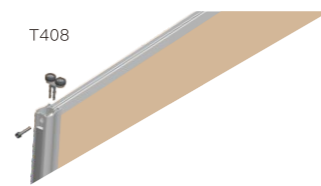

上滑轮安装 Upper runner installation

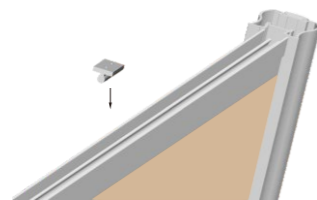

T形件安装 Plastic accessory installation

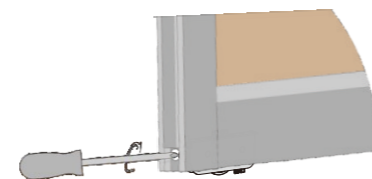

下滑轮高低调节
Down runner adjustment

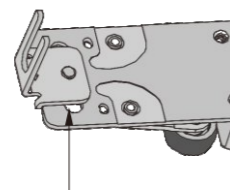

头部脚叉偏位调节
Adjust the deviation of foot in top

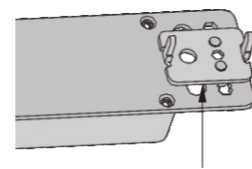

尾部脚叉偏位调节
Adjust the deviation of foot in bottom

T408

ALUMINUM FRAME DOOR SLIDING SYSTEM 铝框专属型--内推智慧系列

独特的弹性滑轮设计，完美贴合轨道滑动顺畅；

静音、安装简便、调试简单；

铝框门专用移门缓冲系统，单门承重5-50kg；

门板厚度不超过35mm；

防跳、防脱钩，自动复位设计；

408B独特专利上轮设计，更舒适安全的缓冲效果，提高家具档次与寿命；

单缓冲：400≤门宽≤1200，高度≤2500；

双缓冲：650≤门宽≤1200，高度≤2500。

Patented Anti Jumping Runners;

Silence, easy installation, easy regulation;

Apply for aluminum frame door;

Automatic hook and reset function;

Single door loading capacity: 5-50kg;

Apply for aluminum frame door thickness up to 35mm;

Single door size

Requirement: single soft closing: width 400-1200mm, height≤2500mm,

double soft closing width 650-1200mm, height≤2500mm.



T408

配件名称 Accessories	数量 Qty		配件图 Drawing
	单缓冲(单门用量) Single soft close (One door)	双缓冲(单门用量) Double soft close (One door)	
上滑轮 Upper runner	1	0	
下滑轮 Down runner	2	2	
T形塑料件 T shape plastic part	1	2	
上滑轮缓冲器 Upper runner damper	1	2	
缓冲器挡件 Damper stopper	1	2	
上轨道 Upper rail	1	1	
下轨道 Down rail	1	1	
铣尾螺丝 Milling tail screws	2	4	
ST4*10 大扁头自攻钉 ST4*10 Cross flat head self tapping screws	1	2	
ST6*30 内六角自攻钉 ST6*30 Hex tapping screws	4	4	

订购说明 Ordering instruction	订货号 Item No.		轻型(15kg以下) Light damper (Less than 15kg)
	T408-TL-390	T408-TL-375	
	T408-TM-390	T408-TM-375	
	T408-TH-390	T408-TH-375	通用型(15~25kg) Standard damper (15~25kg)
			重型(25~50kg) Heavy damper (25~50kg)

T408B

T408B配件 T408B Accessories	数量 Qty		配件图 Drawing
	单缓冲(单门用量) Two damper (One door)		
防跳上滑轮 Anti-jumping upper runner	1		
下滑轮 Down runner	2		
T形塑料件 T shape plastic part	2		
上滑轮缓冲器 Upper runner damper	1		
缓冲器挡件 Damper stopper	1		
上轨道 Upper rail	1		
下轨道 Down rail	1		
铣尾螺丝 Milling tail screws	2		
ST4*10 大扁头自攻钉 ST4*10 Cross flat head self tapping screws	2		
ST6*30 内六角自攻钉 ST6*30 Hex tapping screws	4		

订购说明 Ordering instruction	订货号 Item No.		轻型(15kg以下) Light damper (Less than 15kg)
	T408B-TL-390	T408B-TL-375	
	T408B-TM-390	T408B-TM-375	
	T408B-TH-390	T408B-TH-375	通用型(15~25kg) Standard damper (15~25kg)
			重型(25~50kg) Heavy damper (25~50kg)

安装参数 Installation

门洞与门高尺寸要求
Required dimension of door height and cabinet height.

适用门宽
Suitable for door width.

T为下轨高度, 若 $T > 6$
 $h1 = H - 45 - (T - 6)$

T = Height of down rail, if $T > 6$
 $h1 = H - 45 - (T - 6)$

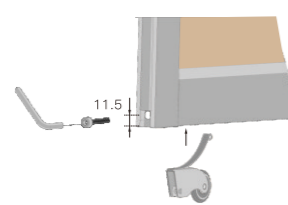
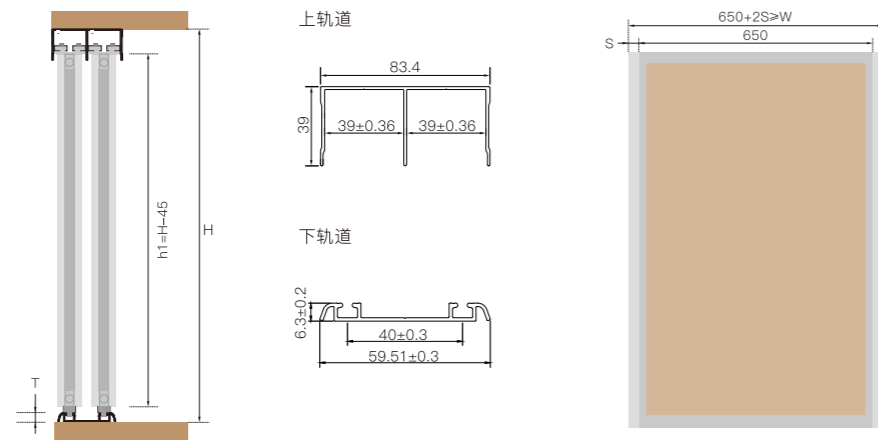

滑轮安装 Runner installation

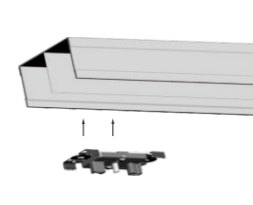

挡件安装 Stopper installation

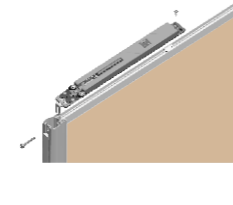

缓冲器安装 Damper installation

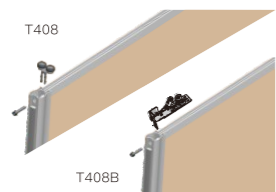

上滑轮安装 Upper runner installation

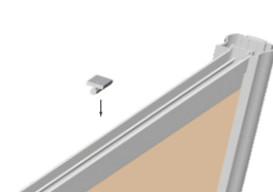

T形件安装 Plastic accessory installation

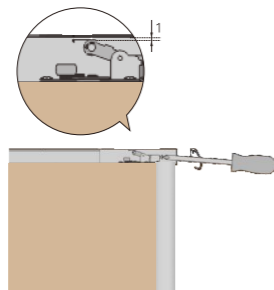

408B上滑轮调节
Anti-jumping upper runner adjustment

注: 防跳轮与上轨留1mm间隙
1mm gap left in the space

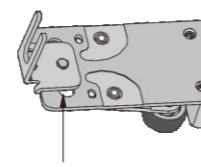

头部脚叉偏位调节
Adjust the deviation of foot in top

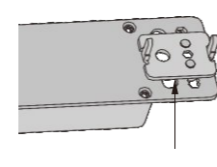

尾部脚叉偏位调节
Adjust the deviation of foot in bottom

T414

FULL SOFT CLOSING SYSTEM 对碰挡件--内推智慧系列

专利产品:

两门对碰时带缓冲, 安全舒适;

独特防跳轮, 柜门滑动更平稳;

六维调节, 适用各种铝柜, 能很好地调节两扇门对碰缓冲距离;

双轮同步弹性设计, 滑轨与滑轨零间隙, 门板不晃动、顺畅。

Patented product;

Full soft closing for 2 doors, smooth and safe;

Patented anti jumping runners, steady movement;

6D adjustment, apply for aluminum frame door, easy regulation for soft-closing distance;

Patented double-roller design, 0mm gap distance between aluminum frame and rail, doors close smoothly.

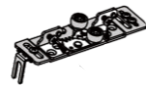

配件名称 Accessories	数量 Qty	对碰挡件(不带缓冲)	对碰挡件(带缓冲)	配件图 Drawing
		Anti-collide stopper (No damper)	Anti-collide stopper (With damper)	
T型件 T shape accessory	1	1	2	
414A对碰挡件 414A Anti-collide stopper	1	1	1	
挡件连接件 Stopper connector	1	1	1	
ST4*10 大扁头自攻钉 ST4*10 Cross pan head tapping screws	1	1	2	
3mm加长六角匙 3mm allen key	1	1	1	
408缓冲器主体 408 Middle door damper	0	1	1	

测量S尺寸，选择合适孔位固定挡件连接件 (S=脚叉到竖框的距离)
Measure "S", fix the stopper connector to the available position.
S=the distance from damper foot to vertical frame.

S≤5, 固定于5前的孔。
5<S≤10, 固定于5与10之间的孔。
10<S≤15, 固定于10与15之间的孔。

Regulate the hole when S≤5
Regulate the hole when 5<S≤10
Regulate the hole when 10<S≤15

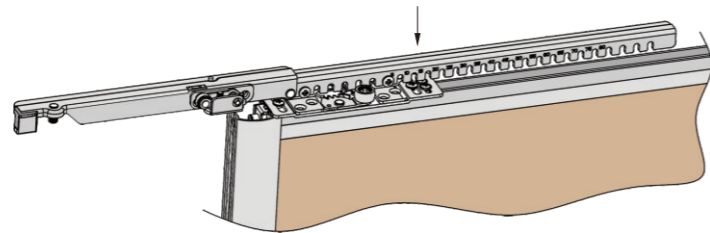

对碰挡件的安装:
1、装门时将T型件装入上横内;
2、将414A对碰挡件固定在上横T型件内(挡件偏位以竖框偏位要匹配)。

Install anti-collide stopper:
Put the stopper connector in the upper rail before install the door.
Fix the anti-collide stopper in the T shape plastic accessory.
(stopper connector's position shall be aligned with frame's shape)

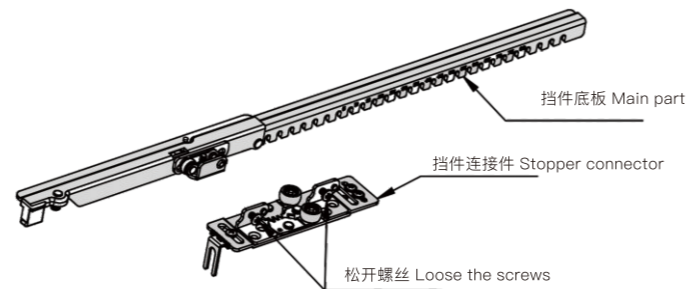

松开螺丝将对碰挡件拆分为挡件底板和挡件连接件。
Loose the screws and split the stopper to main part & stopper connector.

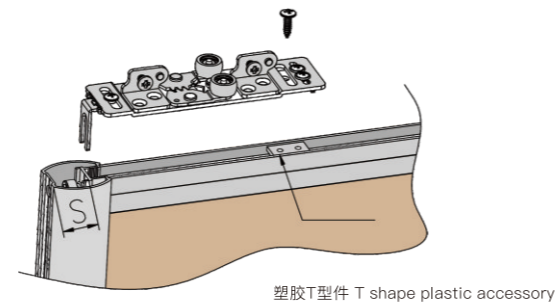

T312

FURNITURE SLIDING DOOR SYSTEM

隐藏型--内推智慧系列

隐藏式移门缓冲系统;

板式与实木的成品或定制家具专用;

阻尼器自动定位功能, 安装快捷方便;

舒适安全的缓冲效果, 提高家具档次与寿命;

单门重≤50kg, 门板厚度≥16mm;

单门尺寸: 500<门宽≤1200, 门高≤2500。

Concealed sliding doors system;

Apply to MDF, plywood & solid wood furniture;

Damper auto position, easy installation;





comfortable and safe function, improve furniture level and service life;

Single door loading capacity: ≤50kg, door thickness≥16mm;

Single door size requirement: width 500~1200mm, height≤2500mm;



T312

配件名称 Accessories	数量 Qty	单缓冲(两门) Single side soft close (Two door)	双缓冲(两门) Double soft close (Two doors)	双缓冲(三门) Double soft close (Three doors)	配件图 Drawing
上滑轮 Upper runner	4	4	4	6	
下滑轮 Down runner	4	4	4	6	
缓冲器 Damper	2	4	4	4	
六角匙 Allen key	1	1	1	1	
ST4*16 十字头自攻钉 ST4*16 Cross tapping screws	32	32	48		

安装参数 Installation

T312A

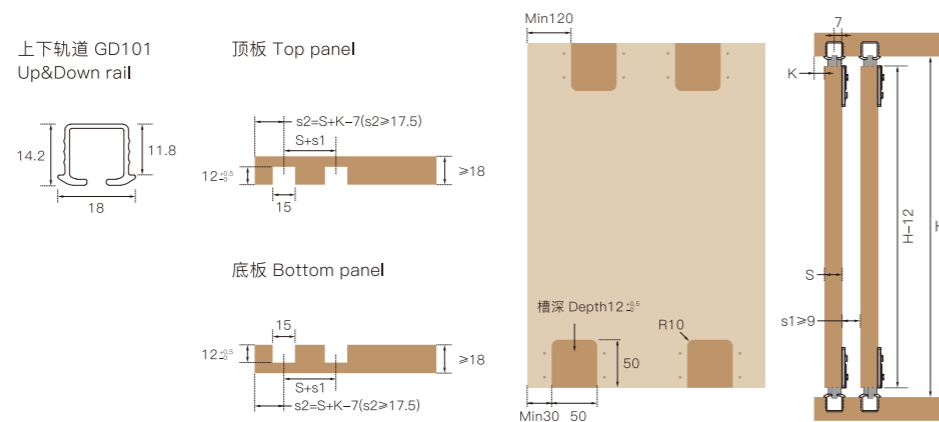

T312B

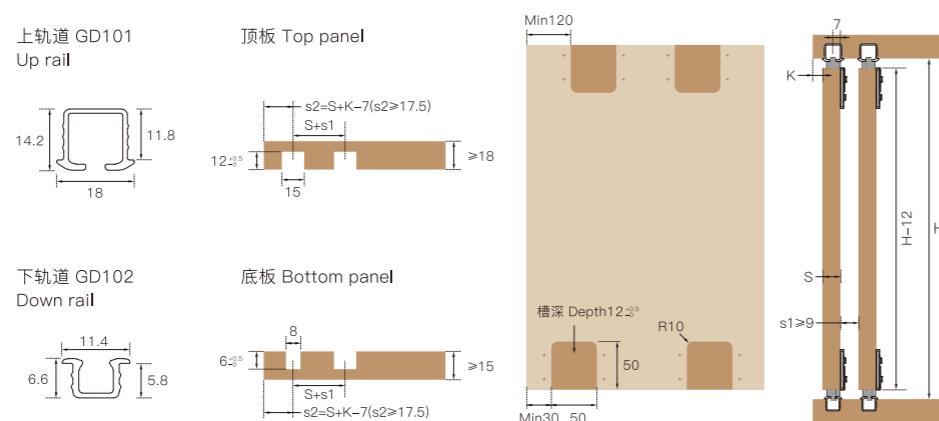

T312C-20

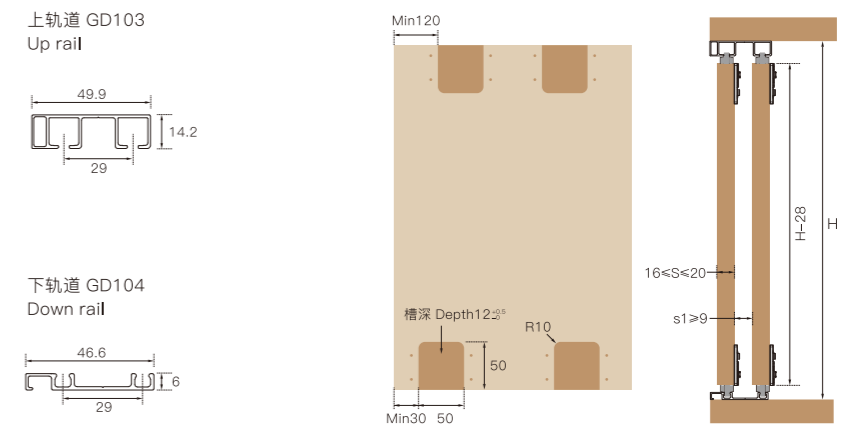



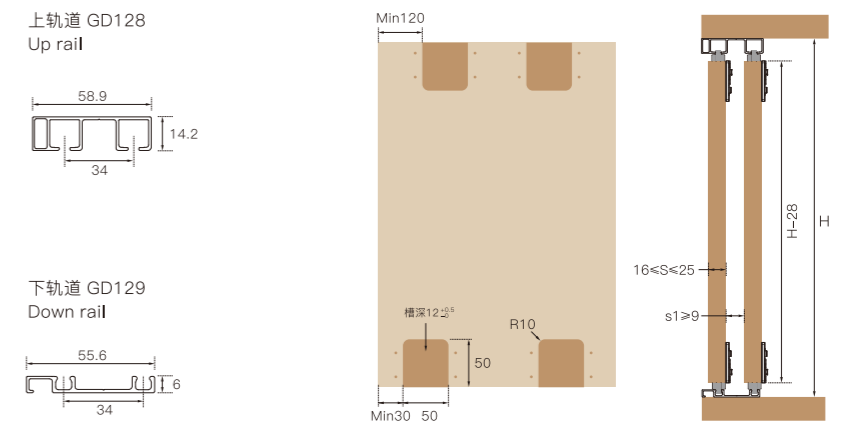

T312C-25

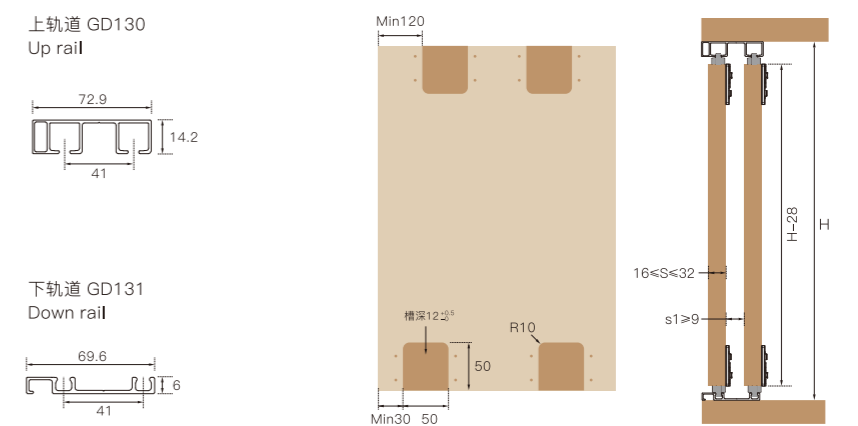

T312C-32



T313

配件名称 Accessories	数量 Qty	单缓冲(两门) Single side soft close (Two door)	双缓冲(两门) Double soft close (Two doors)	双缓冲(三门) Double soft close (Three doors)	配件图 Drawing
上滑轮 Upper runner		4	4	6	
下滑轮 Down runner		4	4	6	
缓冲器 Damper		2	4	4	
六角匙 Allen key		1	1	1	
ST4*16 十字头自攻钉 ST4*16 Cross tapping screws		32	32	48	

安装参数 Installation

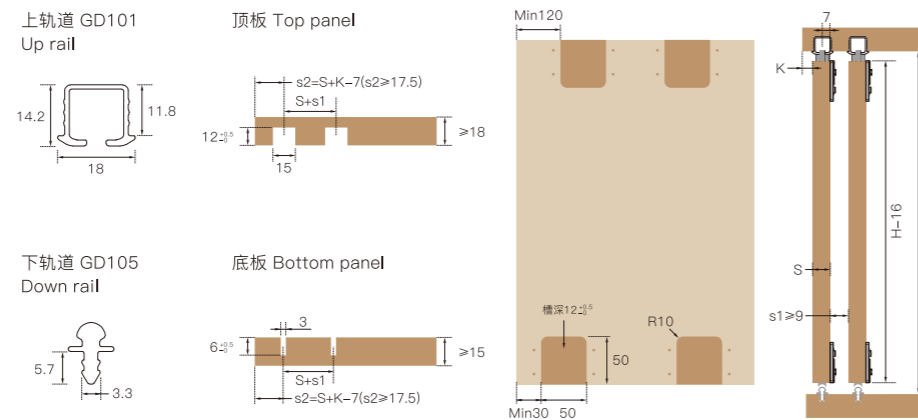

订购说明 Ordering instruction

订购号 Item No. T312A-TH
T312B-TH
T312C-20-TH
T312C-25-TH
T312C-32-TH
T313-TH

通用型
Standard damper

T310

DECORATIVE DOOR SLIDING SYSTEM

装饰型--装饰智美系列

创新明轮结构, 轨道及滑轮安装无需开槽;
可用于装饰柜、书柜木质移门及玻璃移门;
舒适安全的缓冲效果, 提高家具档次, 延长家具寿命;
滑轮采用高强度轴承+进口POM材料, 韧性高、耐磨、静音;
缓冲器自动寻位设计, 轨道采用特殊扣件安装, 更标准、简易;
缓冲器带复位功能、防跳、防脱勾功能;
单门重≤15kg; 门板厚度不限;
单门尺寸: 500<门宽≤1200, 门高≤2500。

Anti jumping runners;
External sliding door system, no cutting or groove needed;
Apply for light wooden door and glass door;
Apply for decoration cabinet or bookcase;
Imported POM material for wheel,
to achieve best silent performance and long lifespan;
Automatic hook coupling function(anti-decoupling);
Single door loading weight≤15kg;
No limite for door thickness;
Single door size requirement: width 500~1200mm, height≤2500mm;



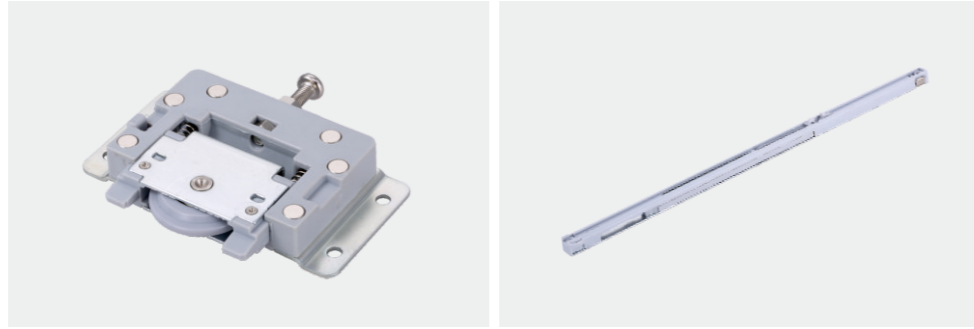

T310-25层板 (25mm)

配件名称 Accessory	数量(单门) Qty	配件图 Drawing
滑轮 Runner	4	
缓冲器 Damper	2	
六角匙 Allen key	1	
T310钻孔定位模板 Drilling positioning template	1	
卡入式铝框 (铝框门可选 编号: GD126) Clip on aluminum frame (Only need for aluminum frame door)	根据长度定制	
粘合式铝框 (铝框门可选 编号: GD127) aluminum frame (Only need for aluminum frame door)	根据长度定制	
铝轨道 (编号: GD125) aluminum rail (Only need for aluminum frame door)	2	

配件包 Accessory bag	数量 Qty	配件图 Drawing
防滑出配件 Anti-slip off part	2	
铝轨道堵头 Cap for aluminum rail ending	2	
轨道塑料扣件 Track plastic fastener	8	
ST4*14十字沉头自攻钉 ST4*14 Cross flat head self tapping screw	24	

注：每条轨道3米内配一包配件包 One accessory bag for one 3 meter track

参数说明 Dimension specification

T310 铝框参数 Aluminum frame door dimension specification

铝框开孔尺寸 Hole size on frame

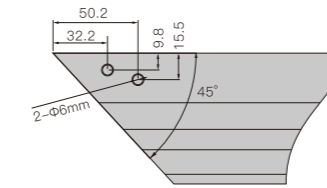

角码 Holder

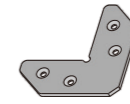

螺丝 Screws

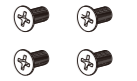



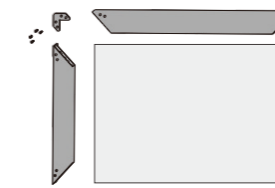



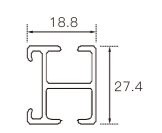
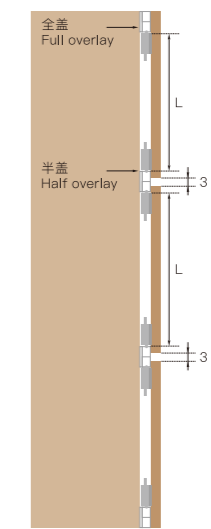
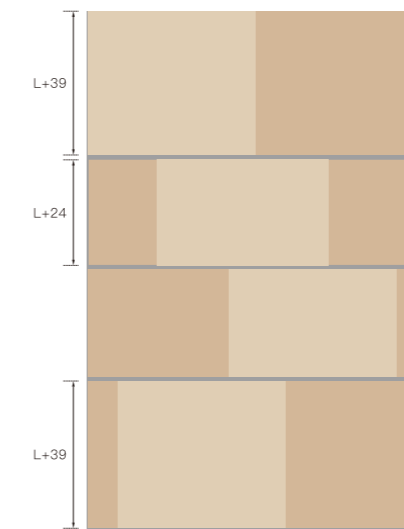
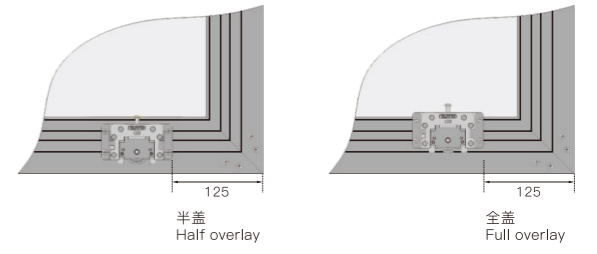

角码拼接铝框和面材
Assembling



定位滑轮区分门板半盖轨道与全盖轨道
Half overlay and Full overlay



T310B-18层板 (18mm)

配件名称 Accessories	数量(单门) Qty	配件图 Drawing
滑轮 Runner	4	
缓冲器 Damper	2	
六角匙 Allen key	1	
T310B钻孔定位模板 Drilling positioning template	1	
铝轨道 (编号: GD132) aluminum rail	2	
配件包 Accessory bag	数量 Qty	配件图 Drawing
防滑出配件 Anti-slip off part	2	
铝轨道堵头 Cap for aluminum rail ending	2	
轨道塑料扣件 Track plastic fastener	8	
ST4*14十字沉头自攻钉 ST4*14 Cross flat head self tapping screw	24	

注：每条轨道3米内配一包配件包 One accessory bag for one 3 meter track

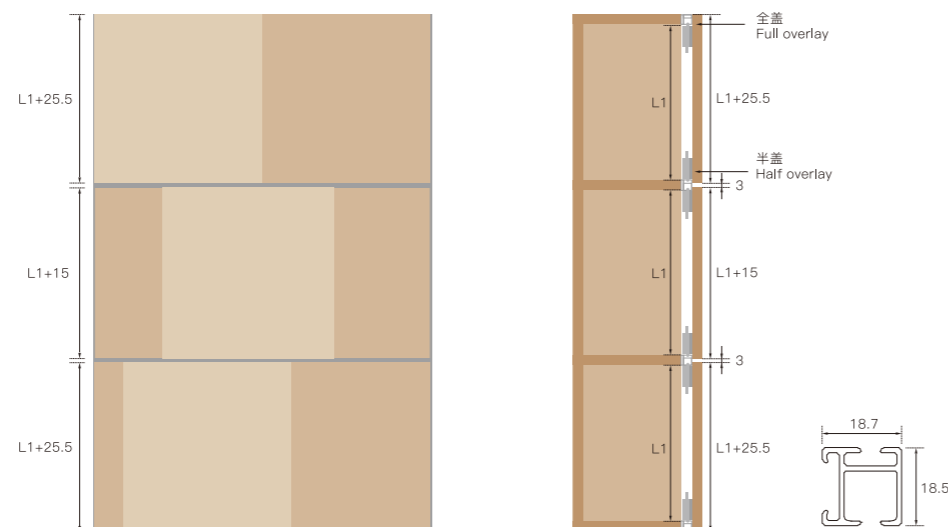

T602

HANGING SLIDING DOOR SYSTEM 精进型--挂趟智畅系列

安装简单便捷, 节省安装成本;
阻尼快装集成, 缓冲配件一体式;
下轮独特设计, 门板装卸方便;
上下同步缓冲, 缓冲效果极佳;
螺丝刀侧向调节, 轻松简便, 调节量大;
自动清洁轨道, 使滑轮运行顺畅、安静;
门厚: 16~46mm, 20kg≤单门重≤80kg;
单门尺寸: 700≤门宽≤1500, 门高≤2500。

Easy installation;
Clip on damper, dampers and parts are integrated;
Special design of down runner, easy to install and uninstall;
Up and down sync damping, with excellent soft close performance;
Screw drivers can adjust from sides easily, with big adjustment;
Auto cleaning the rail, runners move smoothly and silently;
Door thickness: 16~46mm; Door height≤2500mm;
20kg≤Single door weight≤80kg, 700mm≤Single door width≤1500mm;



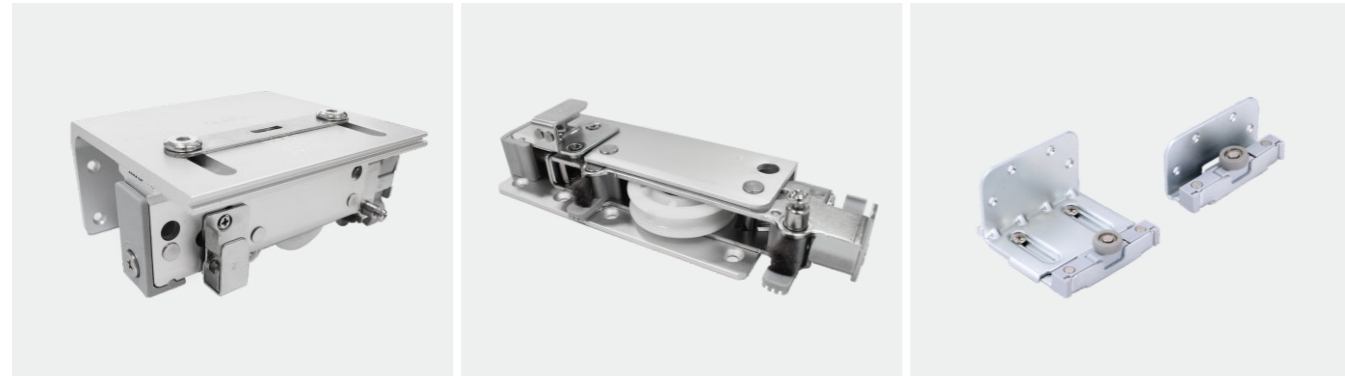

配件名称 Accessories	数量 Qty				配件图 Drawing
	单缓冲(两门用量) Single side soft close (2 doors)	双缓冲(两门用量) Double soft close (2 doors)	双缓冲(三门用量) Double soft close (3 doors)	双缓冲(三门带对碰) Full soft close (3 doors)	
外门上轮左 Left up roller for outside door	1	1	1	1	
外门上轮右 Right up roller for outside door	1	1	1	1	
内门上轮左 Left up roller for inside door	1	1	2	2	
内门上轮右 Right up roller for inside door	1	1	2	2	
外门下轮 Down roller for outside door	2	2	2	2	
内门下轮 Down roller for inside door	2	2	4	4	
上缓冲器 Upper damper	2	4	4	6	
下缓冲器 Down damper	2	4	4	4	
上缓冲器挡件 Stopper	2	4	4	4	
防夹的装置 Anti pinch device	1	1	2	2	
对碰挡件 Anti-collide stopper	0	0	0	1	
ST4*16 十字沉头自攻钉 ST4*16 Cross resseded flat head tapping screws	40	40	60	60	

安装参数 Installation

$K1 = K + T + 8$
 T = 门板厚度 Door Thickness ($16 \leq T \leq 46$)
 F = 侧板厚度 Thickness of side panel

两门单缓冲 Single side soft close for 2 doors

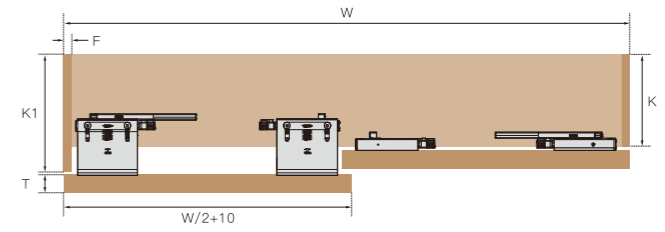

两门双缓冲 Double soft close for 2 doors

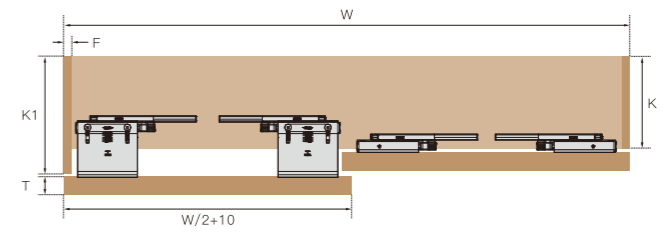

三门双缓冲 Double soft close for 3 doors

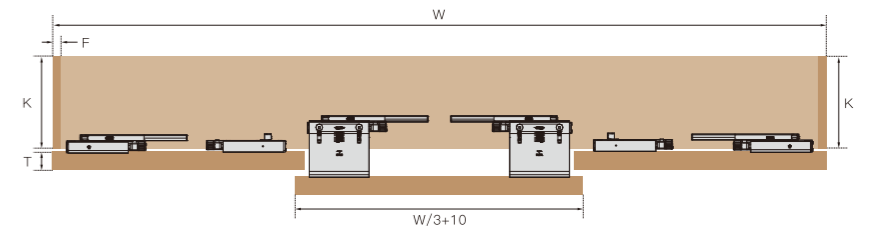

三门双缓冲(三门带对碰) Full soft close for 3 doors

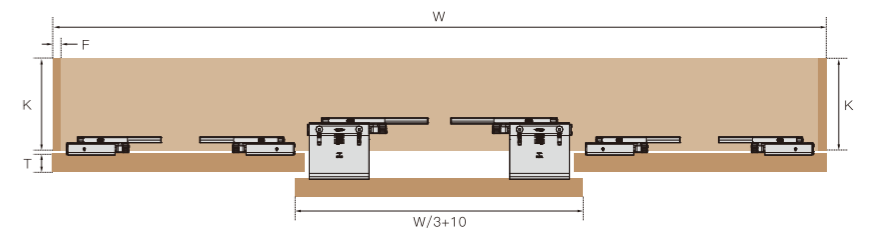

安装参数 Installation

铝材配置

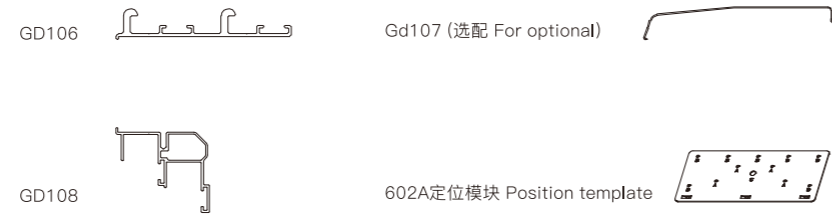

柜体要求 Cabinet Requirements

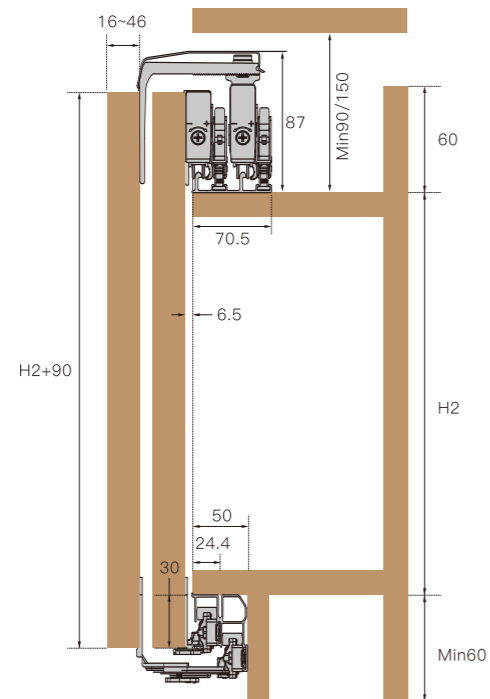
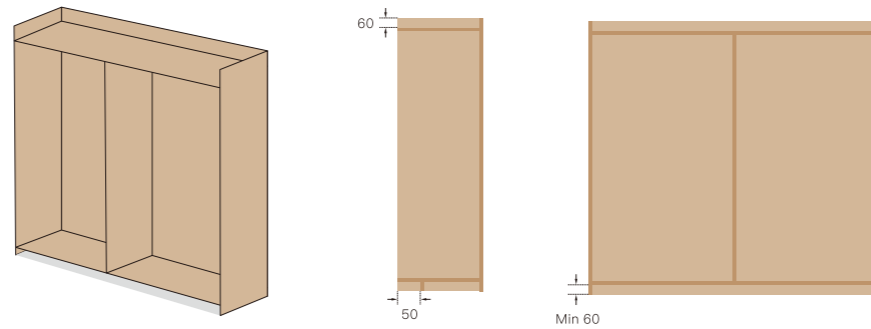

T509

HANGING SLIDING DOOR SYSTEM 精巧型--挂趟智畅系列

专利产品;

极其舒适安全的缓冲效果, 提高家具档次, 延长家具寿命;
滑轮采用高强度轴承+德国POM材料, 韧性高、耐磨、静音;
挂式安装, 具有防跳装置, 可有效防止滑轮跳轨脱落;
柜门高度可调且简单方便;
上下同步阻尼, 带防脱钩及自动复位功能;
单门承重: 20~50kg, 门厚: 16~20mm, 20~25mm;
单门宽度: 700~1500mm, 门高<2500。

Patented anti jumping product;

Imported POM material for wheel, to achieve best silent performance and long lifespan;
Automatic hook coupling function(anti-decoupling);
Up and down sync damping, with excellent soft close performance;
Loading capacity 50kg/door;
Apply for door thickness 16~20mm, 20~25mm;
Door size requirement:
Single door width:700~1500mm, Heigh<2500mmt,
Single door weight: 20~50kg.



T509配件名称 Accessories	数量 Qty	单缓冲(两门用量) Single side soft close (2 doors)	双缓冲(两门用量) Double soft close (2 doors)	双缓冲(三门用量) Double soft close (3 doors)	配件图 Drawing
外门上轮(不含拨杆) Upper runner for outside door	2	0	0		
内门上轮左 Left up roller for inside door	1	1	2		
外门下轮 Down roller for outside door	2	2	2		
外门上轮(含拨杆) Upper runner for outside door (with lever)	0	2	2		
内门上轮右 Right up roller for inside door	1	1	2		
内门下滑轮 Down roller for inside door	2	2	4		
上缓冲器左 Upper left damper	1	2	2		
上缓冲器右 Upper right damper	1	2	2		
下缓冲器 Down damper	2	4	4		
塑料脚撑 Plastic supportor	2	2	4		
吊轨防跳固定块 Fixed block	2	2	2		
定位模块 Position template	1	1	1		
防夹手装置 Anti pinch device	1	1	2		
ST4*16 十字沉头自攻钉 ST4*16 Cross ressed flat head tapping screws	40	40	60		
外门内挡件 Inner stopper for outside door	1	0	0		

注: 三门需加装中门缓冲器 Middle damper added for 3 doors

安装参数 Installation

K1 = K+31
T = 门板厚度 Door Thickness
(16 ≤ T ≤ 20; 20 ≤ T ≤ 25)

前门在左 Outer door is on the left

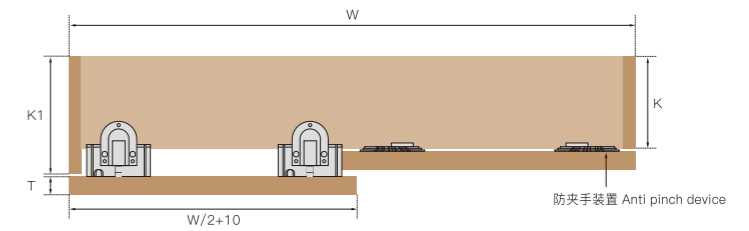

前门在右 Outer door is on the right

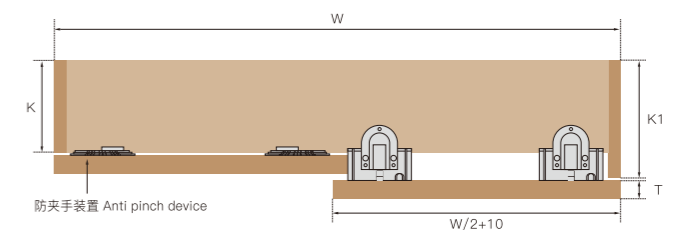

前门在中间 Outer door is in the middle

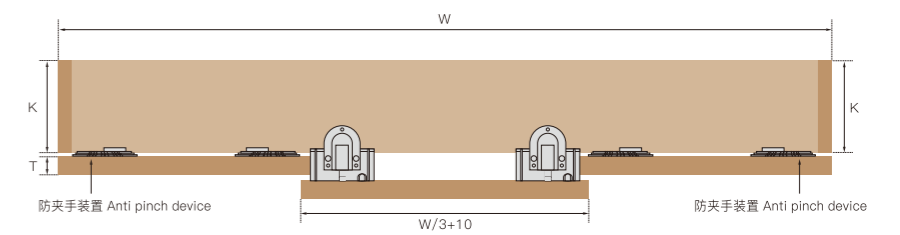

T509-20

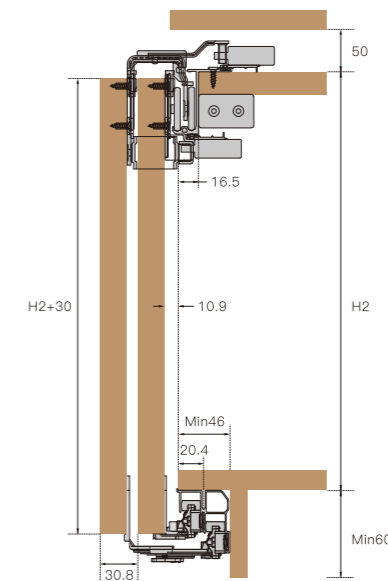

T509-25

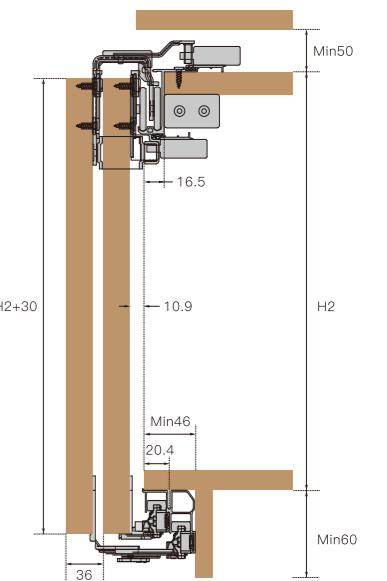

安装参数 Installation

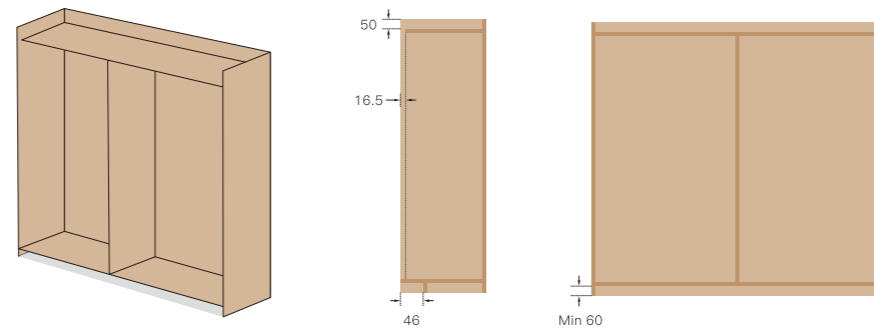

定位模板 Drill hole by position template
F=侧板厚度 Thickness of side panel

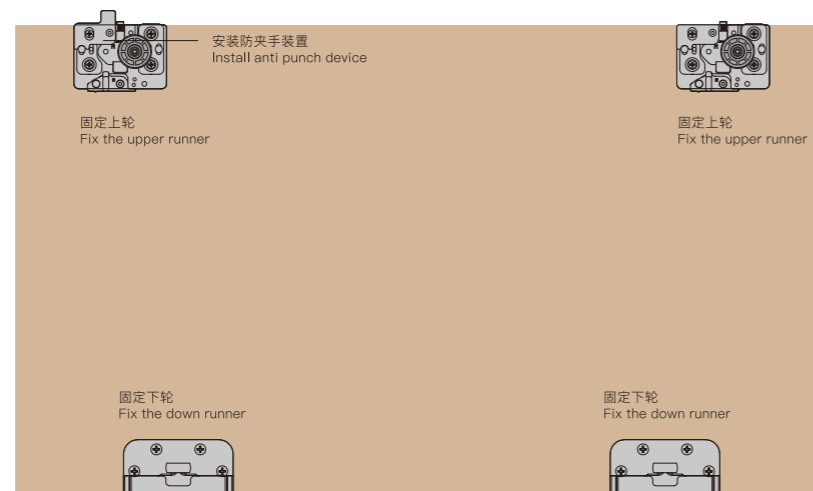
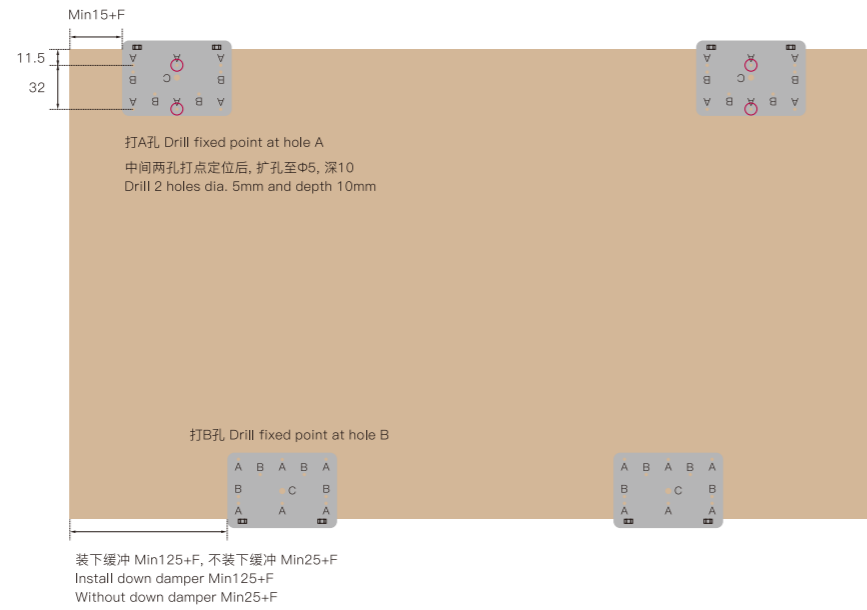

T606

HANGING SLIDING DOOR SYSTEM

精良型--挂趟智畅系列

缓冲一体化, 无需单独安装缓冲器, 下门配件特殊设计, 门板装卸方便;
柜门高度可在侧向用螺丝刀一键调节, 极大简化调节操作;
上挂件锁死功能, 安全防止脱轨, 防跳, 静音效果好;
采用超强度轴承, 单门承重: 20~80kg;
单门尺寸: 600≤门宽≤1200, 门高≤2800, 门厚: 16~46mm。

Anti jumping runners;
Intergrated upper roller with damper for most easy installation;
Easy regulation of door height from side;
Apply for door thickness 16~46mm; Door height≤2800mm;
20kg≤Single door weight≤80kg,
600mm≤Single door width≤1200mm;



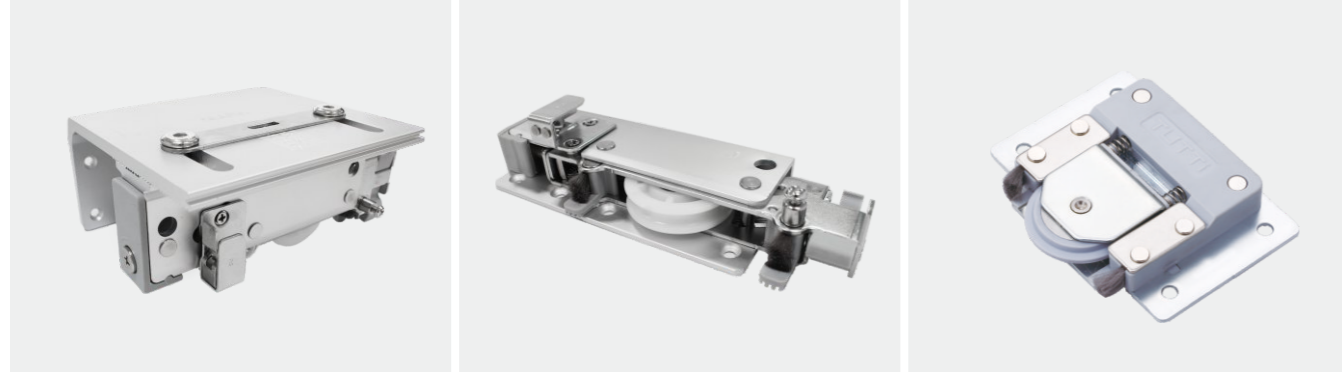

配件名称 Accessories

数量 Qty

单缓冲(两门用量)
Single side soft close (2 doors)

双缓冲(两门用量)
Double soft close (2 doors)

双缓冲(三门用量)
Double soft close (3 doors)

配件图 Drawing

外门上轮左 Left up roller for outside door

1

1

1



外门上轮右 Right up roller for outside door

1

1

1



内门上轮左 Left up roller for inside door

1

1

2



内门上轮右 Right up roller for inside door

1

1

2



下轮 Down roller

4

4

6



定位模块 Position template

1

1

1



上缓冲器 Upper damper

2

4

4



上缓冲器挡件 Stopper

2

4

4



防夹的装置 Anti pinch device

1

1

2



ST4*16 十字沉头自攻钉

40

40

60

ST4*16 Cross resseded flat head tapping screws

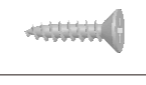

注：三门需加装中门缓冲器 Middle damper added for 3 doors

安装参数 Installation

$K1 = K + T + 8$

T = 门板厚度 Door Thickness ($16 \leq T \leq 46$)

F = 侧板厚度 Thickness of side panel

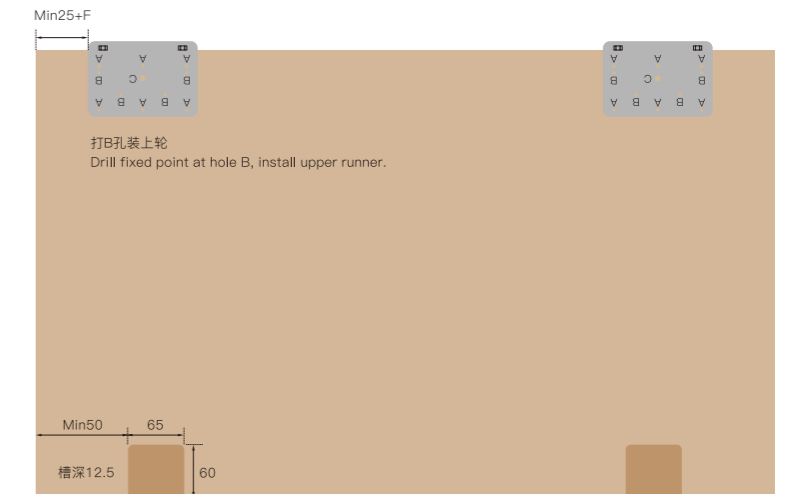
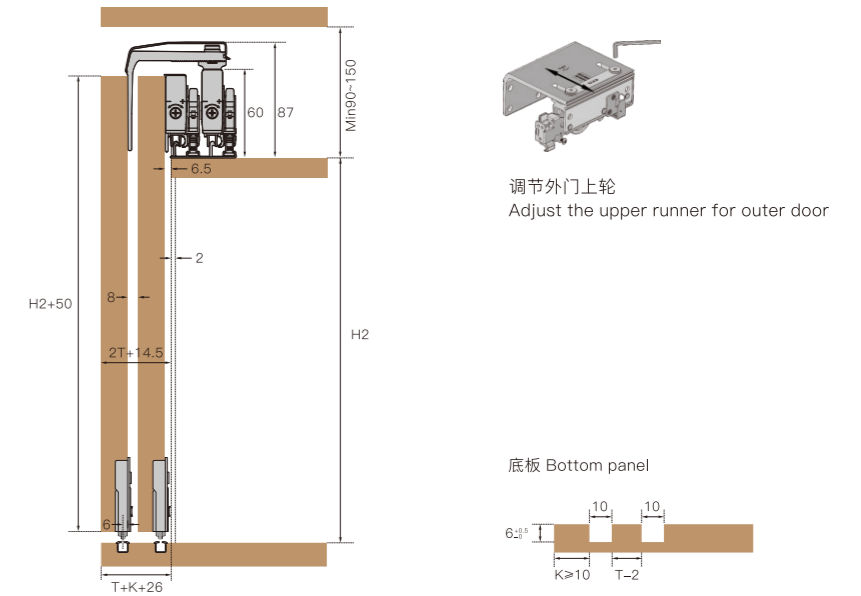
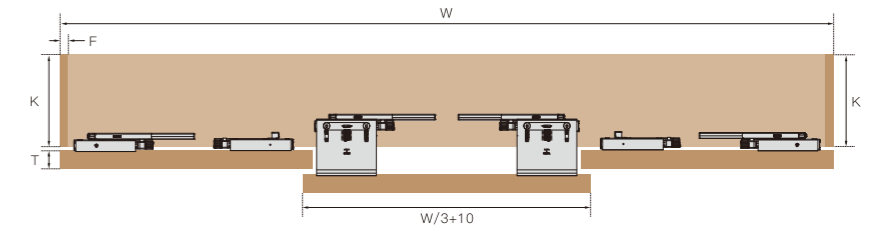
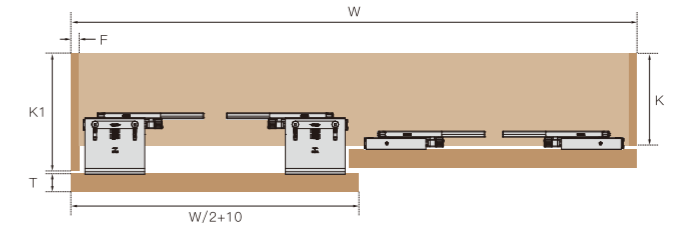

T404

CENTRAL DAMPER/DOUBLE DAMPER 中门型--趟门智配系列

专利产品;

可实现推拉门家具的中门在柜体中间缓冲停靠,防止中门向两端滑动;

产品适用范围:不同偏位的铝框门、木门、挂移门等;

本型号适用于:T306、T309、T408、T509、T602、T606。

Patented product;

Double damper for the center door(For 3 doors option);

Universal use for T306, T309, T408, T509, T602, T606.



订货号 Item No.: T404-306

适用T306中门缓冲
Middle door damper for T306

配件名称 Accessories

数量 Qty

配件图 Drawing

多门缓冲器 Central damper

1



挡件 Stopper

1



ST4*14 十字大扁头自攻钉
ST4*14 Cross flat head tapping screws

8



订货号 Item No.: T404-309

适用T309中门缓冲
Middle door damper for T309

配件名称 Accessories

数量 Qty

配件图 Drawing

多门缓冲器 Central damper

1



挡件 Stopper

1



ST4*14 十字大扁头自攻钉
ST4*14 Cross flat head tapping screws

8



订货号 Item No.: T404-408

适用T308/T408中门缓冲
Middle door damper for T308/T408

配件名称 Accessories

数量 Qty

配件图 Drawing

多门缓冲器 Central damper

1



挡件 Stopper

1



塑胶T形件 T shape plastic part

2



ST4*10 十字大扁头自攻钉
ST4*10 Cross flat head tapping screws

2



ST4*16 十字沉头自攻钉
ST4*16 Cross recessed countersunk head tapping screws

4



订货号 Item No.: T404-509	配件名称 Accessories	数量 Qty	配件图 Drawing
适用T509中门缓冲 Middle door damper for T509	多门缓冲器 Central damper	1	
	挡件 Stopper	1	
	3mm 六角匙 Allen key	1	
	M5*6 大扁头内六角螺钉 Flat head hexagon socket screws	2	
	ST4*16 十字沉头自攻钉 ST4*16 Cross recessed countersunk head tapping screws	4	

订货号 Item No.:T404-602/606	配件名称 Accessories	数量 Qty	配件图 Drawing
适用T602/T606中门缓冲 Middle door damper for T602/T606	多门缓冲器 Central damper	1	
	挡件 Stopper	1	
	M4*16 十字带介螺钉 M4*16 screws	2	
	ST4*16 十字沉头自攻钉 ST4*16 Cross recessed countersunk head tapping screws	4	

T901

GLASS DOOR/WOODEN DOOR HANGING ROLLERS SLIDING 木门/玻璃门吊轮

可用于装饰柜、书柜木质移门及玻璃移门；
舒适安全的缓冲效果，提高家具档次，延长家具寿命；
滑轮采用高强度轴承+进口POM材料，韧性高、耐磨、静音；
缓冲器自动寻位设计，轨道采用特殊扣件安装，更标准、简易；
缓冲器带复位功能、防跳、防脱钩功能；
单门重≤15kg；木门厚：16-19mm，玻璃门厚：5mm
单门尺寸：500≤门宽≤1200。

External sliding door system, no cutting or groove needed;
Apply for light wooden door and glass door;
Apply for decoration cabinet or bookcase;
Imported POM material for wheel,
to achieve best silent performance and long lifespan;
Automatic hook coupling function(anti-decoupling);
Single door loading weight≤15kg;
Wooden door thickness: 16-19mm, glass door thickness: 5mm;
Single door size requirement: width 500-1200mm.



T901A 木门吊轮配件
Wooden Door Hanging Rollers Sliding Accessories



订货号 Item No.: T901A

配件名称 Accessories	数量 Qty	配件图 Drawing
木门挂盒组件 Wooden door top hung components	2	
缓冲器挡件 Damper stopper	2	
木门缓冲器 Wooden door damper	2	
木门下定位 Positioning plate	1	
2mm六角匙 2mm allen key	1	
ST4*16十字沉头自攻钉 ST4*16 cross countersunk head tapping screws	8	

上轨道 (单门)
Upper rail(single door)



GD-160

上轨道 (双门)
Upper rail(double door)

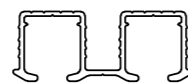

GD-162

下轨道
Down rail



GD-151

T901B 玻璃门吊轮配件
Glass Door Hanging Rollers Sliding Accessories



订货号 Item No.: T901B

配件名称 Accessories	数量 Qty	配件图 Drawing
玻璃门固定夹组件 Glass door fixed block components	2	
缓冲器挡件 Damper stopper	2	
玻璃门缓冲器 Glass door damper	2	
玻璃门下定位 Positioning plate	1	
2mm六角匙 2mm allen key	1	
ST3*10十字沉头自攻钉 ST3*10 cross countersunk head tapping screws	2	

上轨道 (单门)
Upper rail(single door)



GD-160

上轨道 (双门)
Upper rail(double door)

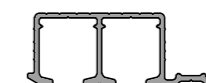

GD-161